

1. PQA82X INNOVATIVE FEATURES

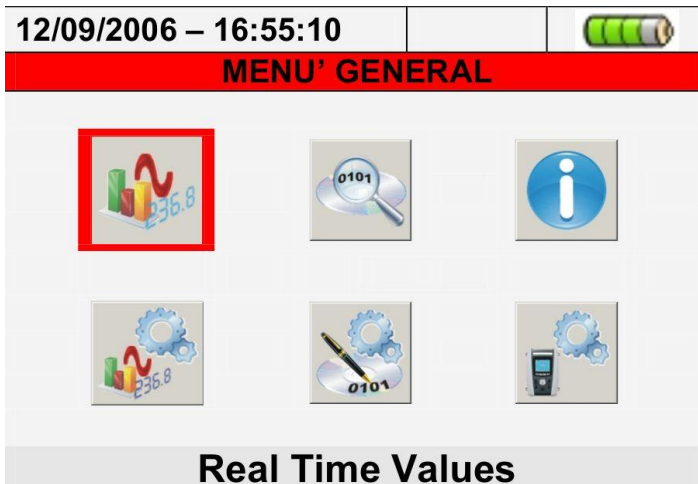

A wide (320x240pxls) graphical color TFT display with “touch screen” to surf the internal functions by using the supplied pointer pen



User friendly icon type interface

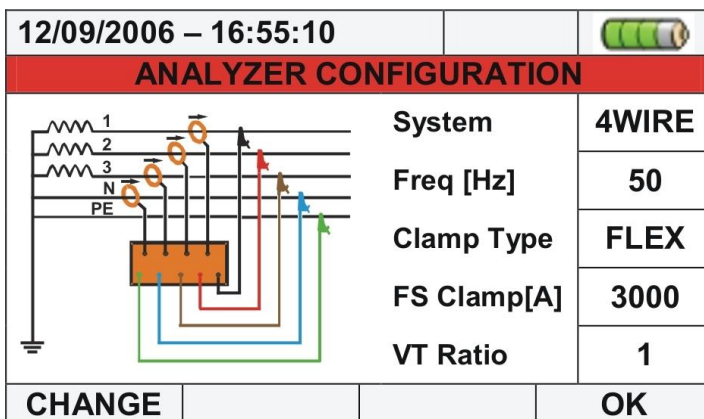

A synoptic connection scheme on the display helps the user while connecting the instrument to the installation under test

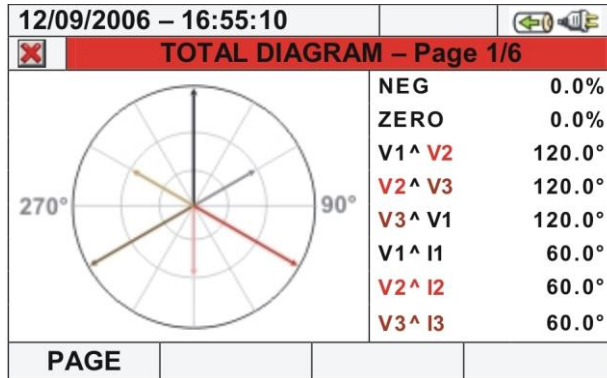

The “Vectorial Diagram” shows the mutual phase angles between voltages and currents vectors



The internal memory (15Mbytes) can be expanded by using the compact flash cards. The instrument has also an USB type A socket to drive USB peripherals like pen drives

MENU GENERAL



Real Time Values icon permits to open the screens of real time values of each measured parameters



Recording Results icon permits the access to all saved recordings and the erasable of internal memory it's possible



Meter Information icon permits the access to a section dedicated to general information of meter



Analyzer Settings icon permits to define the simple and advanced configurations relative to the connection of meter to the installation

By pressing **HELP** key on the keyboard an help on line appears on the display to support the user

2. TOPVIEW SOFTWARE FEATURES

The professional **TOPVIEW** software, available for **Windows® 98/ME/2000/NT/XP/Vista WIN7, WIN8, WIN10 32bit and 64bit** platforms, supplied with PQA82x meters, permits the numerical/graphic view of all recorder data, print report creation with customers customization (logos, text...), print previews, export in XLS and PDF files and much more.

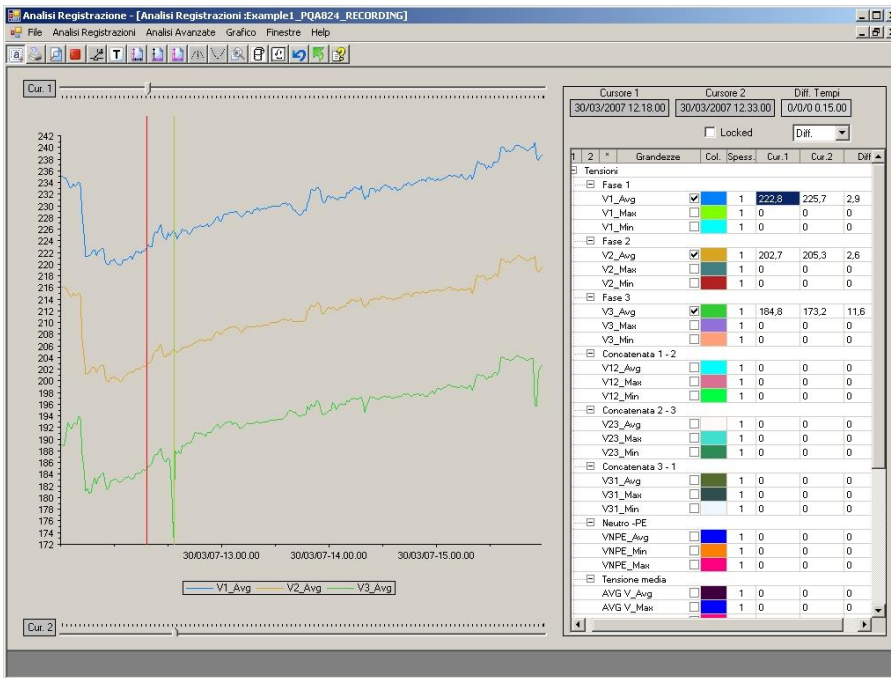

Graphic view window of recorded data with tree selection type structure

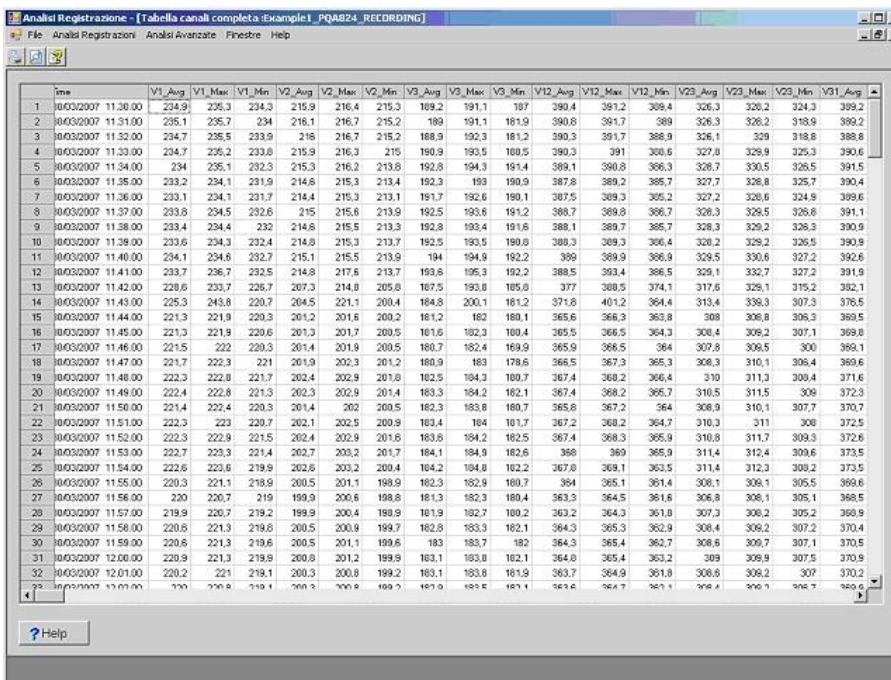

The screenshot displays the 'Tabella canali completa' window, showing a numerical view of recorded data. The table contains the following columns:

Time	V1_Avg	V1_Max	V1_Min	V2_Avg	V2_Max	V2_Min	V3_Avg	V3_Max	V3_Min	V12_Avg	V12_Max	V12_Min	V23_Avg	V23_Max	V23_Min	V31_Avg
1 03/03/2007 11:30:00	234.9	235.3	234.3	215.9	216.4	215.3	189.2	191.1	187	380.4	381.2	380.4	326.3	326.2	324.3	389.2
2 03/03/2007 11:31:00	235.1	235.7	234	216.1	216.7	215.2	189	191.1	181.9	380.8	381.7	380.9	326.3	326.2	318.9	389.2
3 03/03/2007 11:32:00	234.7	235.5	233.9	216	216.7	215.2	188.9	192.3	181.2	380.3	381.7	380.9	326.1	326	318.8	388.8
4 03/03/2007 11:33:00	234.7	235.2	233.8	215.9	216.3	215	189.9	193.5	180.5	380.3	381	380.6	327.8	326.9	325.3	390.6
5 03/03/2007 11:34:00	234	235.1	232.3	215.3	216.2	213.9	182.8	194.3	181.4	380.1	380.8	380.3	326.7	330.5	328.5	391.5
6 03/03/2007 11:35:00	233.2	234.1	231.9	214.6	215.3	213.4	182.3	193	180.9	387.8	389.2	385.7	327.7	328.8	325.7	390.4
7 03/03/2007 11:36:00	233.1	234.1	231.7	214.4	215.3	213.1	181.7	192.6	180.1	387.5	389.3	385.2	327.2	328.6	324.9	389.6
8 03/03/2007 11:37:00	233.8	234.5	232.6	215	215.6	213.9	182.5	193.6	181.2	388.7	389.8	386.7	328.3	329.5	326.8	391.1
9 03/03/2007 11:38:00	233.4	234.4	232	214.8	215.5	213.3	182.8	193.4	181.6	388.1	389.7	385.7	328.3	329.2	326.3	390.9
10 03/03/2007 11:39:00	233.6	234.3	232.4	214.8	215.3	213.7	182.5	193.5	180.6	388.3	389.3	386.4	328.2	329.2	326.5	390.9
11 03/03/2007 11:40:00	234.1	234.8	232.7	215.1	215.5	213.9	184	194.9	182.2	389	389.9	386.9	329.5	330.8	327.2	392.6
12 03/03/2007 11:41:00	233.7	236.7	232.5	214.8	217.6	213.7	183.6	195.3	182.2	388.5	393.4	386.5	329.1	332.7	327.2	391.9
13 03/03/2007 11:42:00	228.6	233.7	226.7	207.3	214.8	205.8	187.5	193.8	185.6	377	388.5	374.1	317.6	326.1	315.2	382.1
14 03/03/2007 11:43:00	225.3	243.8	220.7	204.5	221.1	200.4	184.8	200.1	181.2	371.8	401.2	364.4	313.4	338.3	307.3	376.5
15 03/03/2007 11:44:00	221.3	221.9	220.3	201.2	201.6	200.2	181.2	182	180.1	365.6	366.3	363.8	308	308.8	306.3	389.5
16 03/03/2007 11:45:00	221.3	221.9	220.6	201.3	201.7	200.5	181.6	182.3	180.4	365.5	366.5	364.3	308.4	309.2	307.1	389.8
17 03/03/2007 11:46:00	221.5	222	220.3	201.4	201.9	200.5	180.7	182.4	180.9	365.9	366.5	364	307.8	308.5	300	389.1
18 03/03/2007 11:47:00	221.7	222.3	221	201.9	202.3	201.2	180.9	183	178.6	366.5	367.3	365.3	308.3	310.1	306.4	389.6
19 03/03/2007 11:48:00	222.3	222.8	221.7	202.4	202.9	201.8	182.5	184.3	180.7	367.4	368.2	366.4	310	311.3	308.4	371.6
20 03/03/2007 11:49:00	222.4	222.8	221.5	202.3	202.9	201.4	183.3	184.2	182.1	367.4	368.2	365.7	310.5	311.5	308	372.3
21 03/03/2007 11:50:00	221.4	222.4	220.3	201.4	202	200.5	182.3	183.8	180.7	365.8	367.2	364	308.9	310.1	307.7	370.7
22 03/03/2007 11:51:00	222.3	223	220.7	202.1	202.5	200.9	183.4	184	181.7	367.2	368.2	364.7	310.3	311	308	372.5
23 03/03/2007 11:52:00	222.3	222.9	221.5	202.4	202.9	201.6	183.6	184.2	182.5	367.4	368.3	365.9	310.8	311.7	309.3	372.6
24 03/03/2007 11:53:00	222.7	223.3	221.4	202.7	203.2	201.7	184.1	184.9	182.6	368	369	365.9	311.4	312.4	309.6	373.5
25 03/03/2007 11:54:00	222.6	223.6	219.9	202.6	203.2	200.4	184.2	184.8	182.2	367.6	369.1	363.5	311.4	312.3	309.2	373.5
26 03/03/2007 11:55:00	220.3	221.1	218.9	200.5	201.1	198.9	182.3	182.9	180.7	364	365.1	361.4	308.1	308.1	305.5	389.6
27 03/03/2007 11:56:00	220	220.7	219	199.9	200.6	198.8	181.3	182.3	180.4	363.3	364.5	361.6	306.8	306.1	305.1	388.5
28 03/03/2007 11:57:00	219.9	220.7	219.2	199.9	200.4	198.9	181.9	182.7	180.2	363.2	364.3	361.8	307.3	306.2	305.2	388.9
29 03/03/2007 11:58:00	220.6	221.3	219.6	200.5	200.9	199.7	182.8	183.3	182.1	364.3	365.3	362.9	308.4	308.2	307.2	370.4
30 03/03/2007 11:59:00	220.6	221.3	219.6	200.5	201.1	199.6	183	183.7	182	364.3	365.4	362.7	308.6	309.7	307.1	370.5
31 03/03/2007 12:00:00	220.9	221.3	219.9	200.8	201.2	199.9	183.1	183.8	182.1	364.6	365.4	363.2	309	309.9	307.5	370.9
32 03/03/2007 12:01:00	220.2	221	219.1	200.3	200.8	199.2	183.1	183.8	181.9	363.7	364.9	361.8	308.6	309.2	307	370.2

Numerical view window of all recorded data divided by integrated period

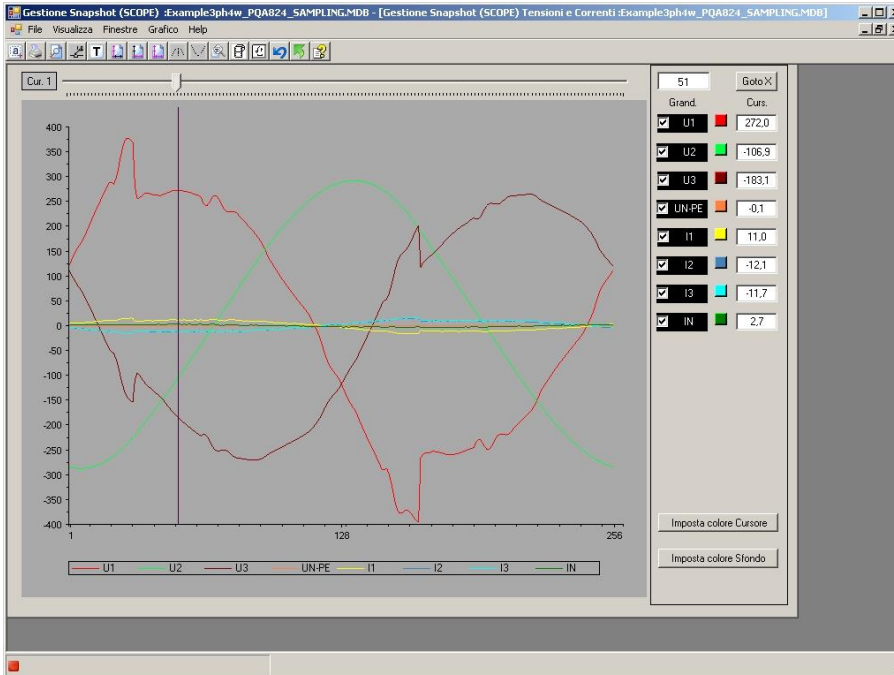

Real time Waveform screen of each parameters

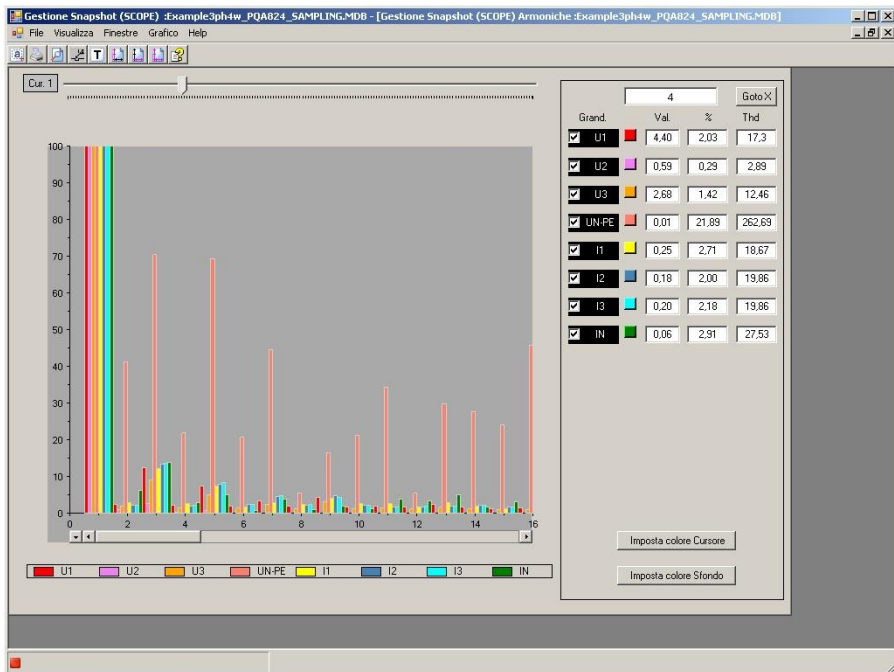

Histogram screen of harmonic analysis of voltage and currents up to 49° order

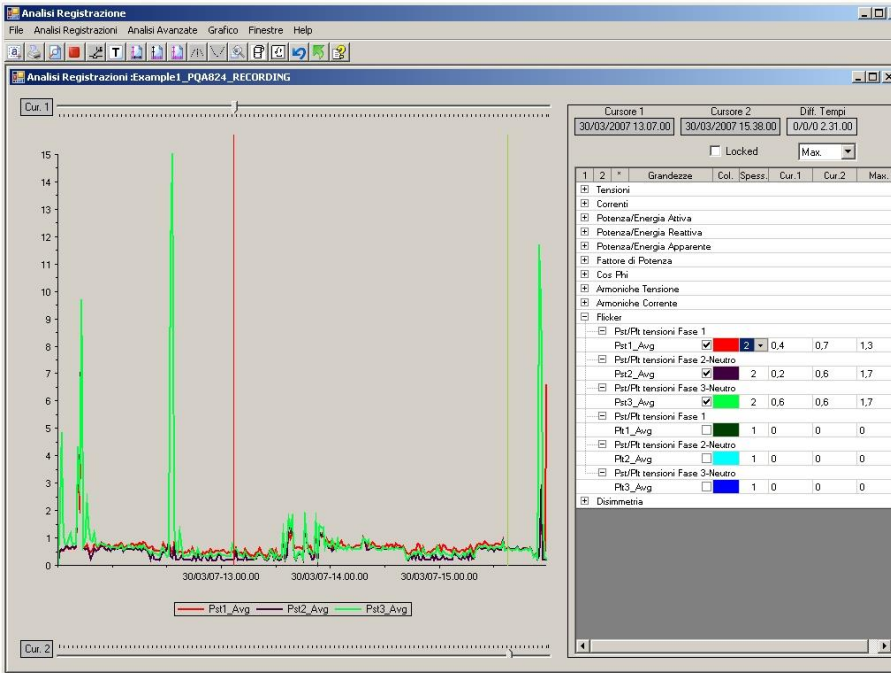

Numerical/graphical screen of voltage Flicker

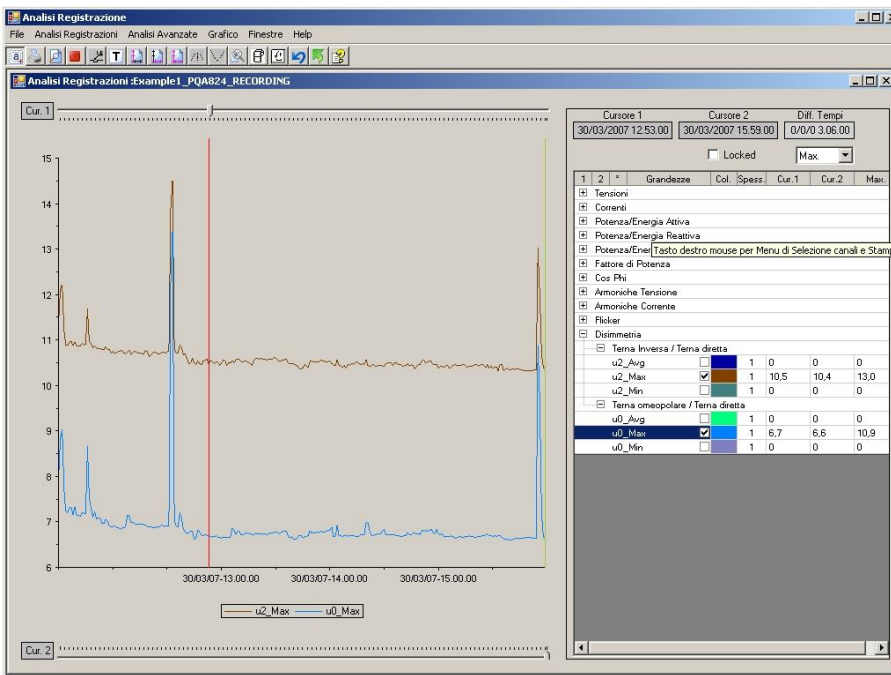

Numerical/graphical screen of voltage unbalance

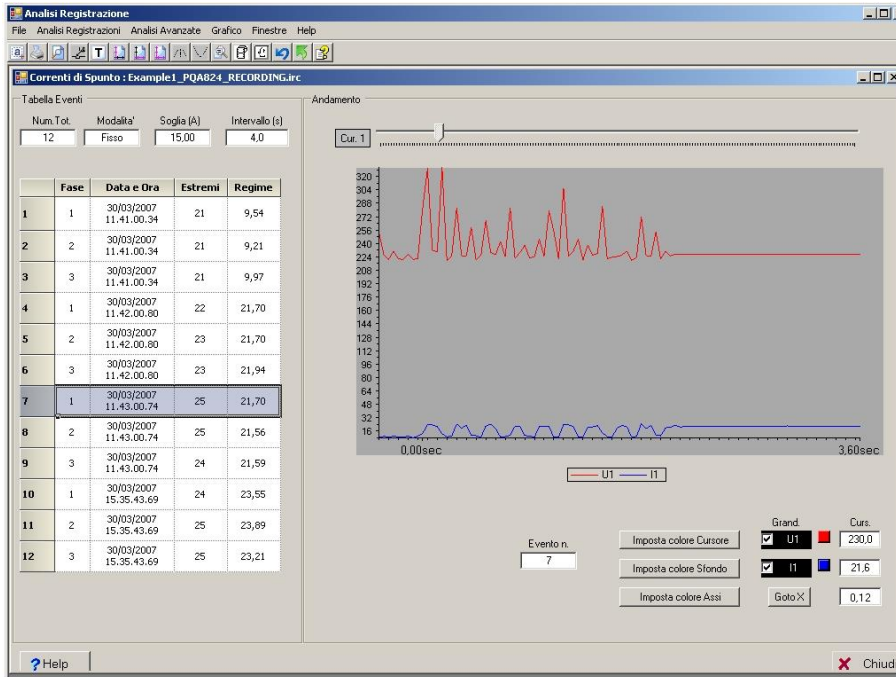

Numerical/graphical analysis
rush current events with
10ms resolution

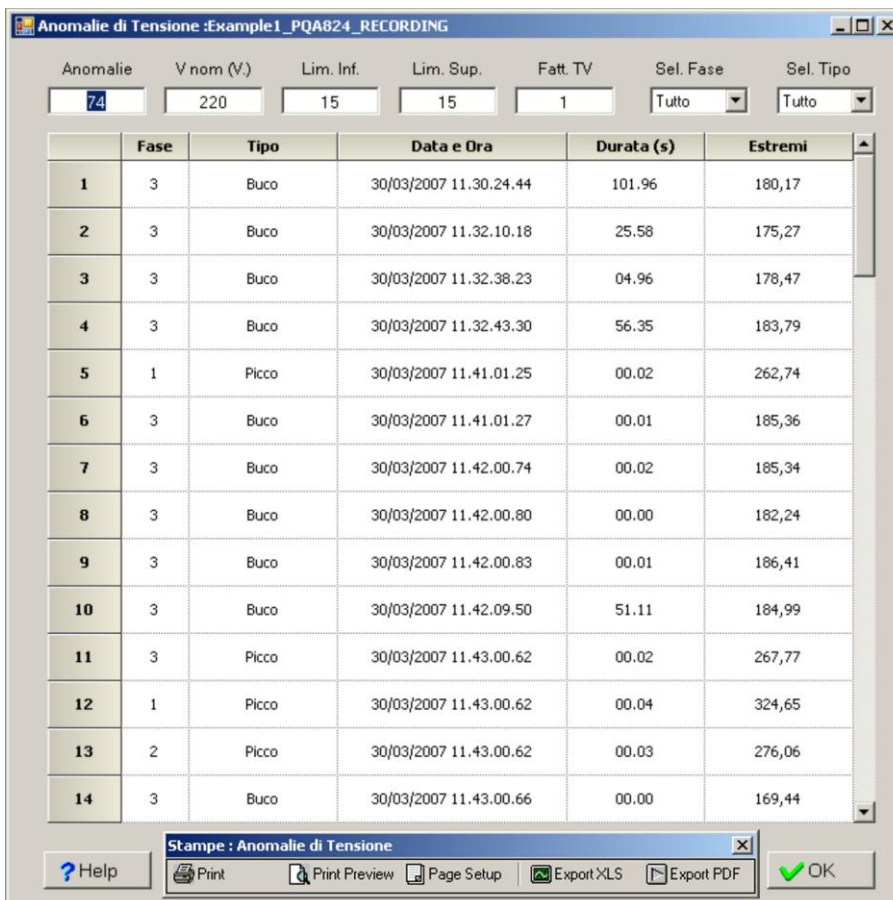

Anomalie di Tensione :Example1_PQA824_RECORDING

Anomalie	V nom (V)	Lim. Inf.	Lim. Sup.	Fatt. TV	Sel. Fase	Sel. Tipo
74	220	15	15	1	Tutto	Tutto

	Fase	Tipo	Data e Ora	Durata (s)	Estremi
1	3	Bucco	30/03/2007 11.30.24.44	101.96	180,17
2	3	Bucco	30/03/2007 11.32.10.18	25.58	175,27
3	3	Bucco	30/03/2007 11.32.38.23	04.96	178,47
4	3	Bucco	30/03/2007 11.32.43.30	56.35	183,79
5	1	Picco	30/03/2007 11.41.01.25	00.02	262,74
6	3	Bucco	30/03/2007 11.41.01.27	00.01	185,36
7	3	Bucco	30/03/2007 11.42.00.74	00.02	185,34
8	3	Bucco	30/03/2007 11.42.00.80	00.00	182,24
9	3	Bucco	30/03/2007 11.42.00.83	00.01	186,41
10	3	Bucco	30/03/2007 11.42.09.50	51.11	184,99
11	3	Picco	30/03/2007 11.43.00.62	00.02	267,77
12	1	Picco	30/03/2007 11.43.00.62	00.04	324,65
13	2	Picco	30/03/2007 11.43.00.62	00.03	276,06
14	3	Bucco	30/03/2007 11.43.00.66	00.00	169,44

Numerical screen of voltage
anomalies (sags, swells) events
with 10ms resolution. Directly
export operation both in XLS
and PDF format files

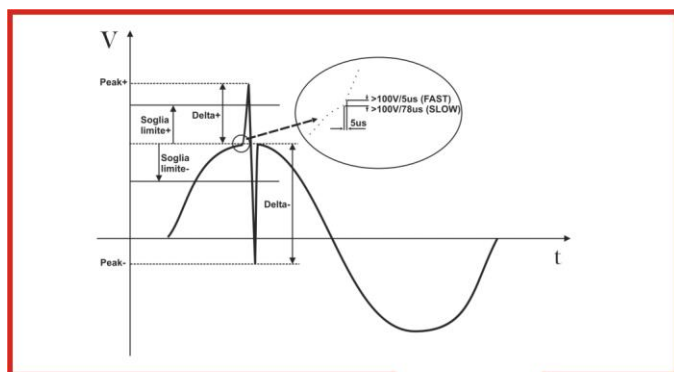
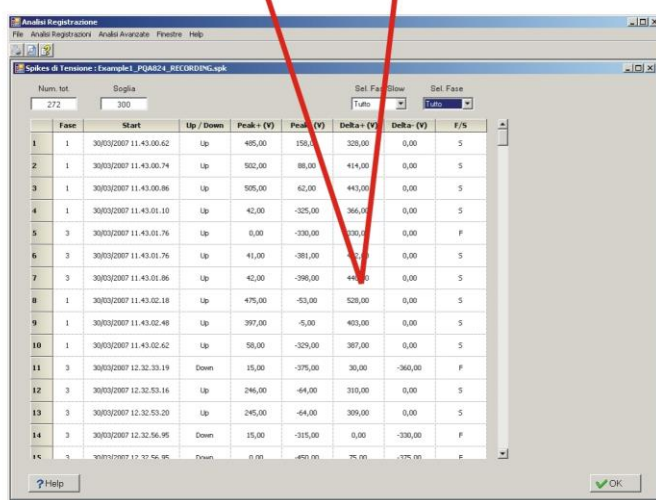
Num. tot	Soglia	Set. Fas	Slow	Set. Fase				
272	300	Tutto	Tutto	Tutto				
Fase	Start	Up / Down	Peak+ (V)	Peak- (V)	Delta+ (V)	Delta- (V)	F/S	
1	1	30/03/2007 11:43:00.62	Up	485,00	158,00	328,00	0,00	S
2	1	30/03/2007 11:43:00.74	Up	502,00	88,00	414,00	0,00	S
3	1	30/03/2007 11:43:00.86	Up	505,00	42,00	443,00	0,00	S
4	1	30/03/2007 11:43:01.10	Up	42,00	-325,00	366,00	0,00	S
5	3	30/03/2007 11:43:01.76	Up	0,00	-330,00	330,00	0,00	F
6	3	30/03/2007 11:43:01.76	Up	41,00	-381,00	340,00	0,00	S
7	3	30/03/2007 11:43:01.86	Up	42,00	-398,00	344,00	0,00	S
8	1	30/03/2007 11:43:02.18	Up	475,00	-53,00	528,00	0,00	S
9	1	30/03/2007 11:43:02.48	Up	397,00	-5,00	403,00	0,00	S
10	1	30/03/2007 11:43:02.62	Up	-58,00	-329,00	307,00	0,00	S
11	3	30/03/2007 12:32:33.19	Down	15,00	-375,00	30,00	-360,00	F
12	3	30/03/2007 12:32:53.16	Up	246,00	-44,00	310,00	0,00	S
13	3	30/03/2007 12:32:53.20	Up	245,00	-64,00	309,00	0,00	S
14	3	30/03/2007 12:32:56.95	Down	15,00	-315,00	0,00	-330,00	F
15	3	30/03/2007 12:32:56.95	Down	0,00	-450,00	75,00	-375,00	F

Numerical analysis of voltage spikes events with 5 μ s resolution (PQA824 only)

3. MODELS AND FEATURES

Measurements	PQA823	PQA824
Phase-Phase, Phase-Neutral, Phase-Ground AC TRMS voltages	✓	✓
DC voltages	✓	✓
Phases and neutral AC TRMS currents	✓	✓
DC currents	✓	✓
Power factor	✓	✓
Active, reactive and apparent powers and energies	✓	✓
DC power	✓	✓
Voltage harmonics up to the 64 th order (real time visualisation)	✓	✓
Current harmonics up to the 64 th order (real time visualisation)	✓	✓
Voltage harmonics up to the 49 th order (recordings)	✓	✓
Current harmonics up to the 49 th order (recordings)	✓	✓
Voltage anomalies (sags, swells) with 10ms resolution	✓	✓
Flicker in compliance to EN50160	✓	✓
Voltage unbalance in compliance to EN50160	✓	✓
Inrush currents	✓	✓
Voltage spikes and fast transients (5 μ s resolution)		✓



4. ELECTRICAL SPECIFICATIONS

Accuracy is indicated as \pm (% readings + no. of digits) at 23°C \pm 5°C, con relative humidity <60%HR

TRMS AC/DC phase - neutral / phase - ground voltage, single / three phase systems

Range (V)	Resolution (V)	Accuracy	Input impedance
0.0 ÷ 600.0	0.1	\pm (0.5%rdg + 2dgt)	10M Ω

Max crest factor: 2 ; Voltage value <2.0V is zeroed; The meter could be connected to external VTs with selectable ratio from 1 to 3000

TRMS AC/DC phase - phase voltage, three phase systems

Range (V)	Resolution (V)	Accuracy	Input impedance
0.0 ÷ 1000.0	0.1	\pm (0.5% rdg + 2 dgt)	10M Ω

Max crest factor: 2; Voltage value <2.0V is zeroed ; The meter could be connected to external VTs with selectable ratio from 1 to 3000

Phase - neutral voltage anomalies, single / three phase systems

Range (V)	Voltage resolution (V)	Voltage accuracy	Time resolution (ms)	Time accuracy
0.0 ÷ 600.0	0.2	\pm (1.0% rdg + 2 dgt)	10	\pm 10ms

Maximum crest factor: 2 ; Voltage value <2.0V is zeroed ;The meter could be connected to external VTs with selectable ratio from 1 to 3000 ; The voltage threshold can be set from \pm 1 to \pm 30%

Phase - phase voltage anomalies, three phase systems

Range (V)	Voltage resolution (V)	Voltage accuracy	Time resolution (ms)	Time accuracy
0.0 ÷ 1000.0	0.2	\pm (1.0% rdg + 2 dgt)	10	\pm 10ms

Maximum crest factor: 2; Voltage value <2.0V is zeroed ; The meter could be connected to external VTs with selectable ratio from 1 to 3000 ; The voltage threshold can be set from \pm 1 to \pm 30%

Voltage spikes – Phase-Ground Voltage single / three phase systems (only PQA824)

Range (V)	Voltage resolution (V)	Voltage accuracy	Time accuracy (50Hz)	Detection time (50Hz)
-1000 ÷ -100	1	\pm (2.0%rdg+60V)	\pm 10ms	78 μ s – 2.5ms (SLOW)
100 ÷ 1000				
-6000 ÷ -100	15	\pm (10%rdg+100V)		20 μ s - 160 μ s (FAST)
100 ÷ 6000				

Detection threshold selectable from 100V to 5000V

Max number of detectable events: 20000

DC/AC TRMS current with standard STD transducer clamp

Range (mV)	Crest factor	Resolution (mV)	Accuracy (*)	Input impedance	Overload protection
0.0 ÷ 1000.0	\leq 3	0.1	\pm (0.5%rdg + 0.06%FS)	510k Ω	5V

(*) Accuracy of the transducer excluded ; FS = Full Scale clamp ; current values <0.1%FC are zeroed

TRMS AC current with flex FlexINT transducer – 300A full scale

Range (A)	Crest factor	Resolution (A)	Accuracy (*)	Input impedance	Overload protection
0.0 ÷ 49.9	\leq 3	0.1	\pm (0.5%rdg+ 0.24%FS)	510k Ω	5V
50.0 ÷ 300.0			\pm (0.5% rdg + 0.06%FS)		

(*) Accuracy of the transducer excluded ; FS = Full Scale clamp ; current values <1A are zeroed

TRMS AC current with flex FlexINT transducer – 3000A full scale

Range (A)	Crest factor	Resolution (A)	Accuracy (*)	Input impedance	Overload protection
0.0 ÷ 3000.0	\leq 3	0.1	\pm (0.5% rdg + 0.06%FS)	510k Ω	5V

(*) Accuracy of the transducer excluded ; FS = Full Scale clamp ; current values <5A are zeroed



Inrush current

Range	Voltage resolution(V)	Voltage accuracy	Time resolution (50Hz)	Time accuracy (50Hz)
Depending on type of clamp	Depending on type of clamp	$\pm(1.0\%rdg+0.4\%FS)$	10ms	$\pm 10ms$

Max crest factor = 3 ; Max number of detectable events: 1000

Frequency (voltmetric and amperometric inputs)

Range (Hz)	Resolution (Hz)	Accuracy
42.5 ÷ 69.0	0.1	$\pm (0.2\% rdg + 1dgt)$

Voltage and current harmonics

Order	Resolution	Accuracy (*)
DC ÷ 64 th	0.1V / 0.1A	$\pm (5\%rdg + 5dgt)$

(*) Add to the error of correspondent TRMS parameters

Power – Single phase and three phase systems (@cosφ>0.5, V_{mis}>60V)

Parameter [W, VAR, VA]	FS clamp	Range [W, VAR, VA]	Accuracy	Resolution [W, VAR, VA]
Active Power Reactive Power Apparent Power	FS ≤ 1A	0.0 – 999.9	$\pm (1.0\%rdg + 6dgt)$	0.1
		1.000 – 9.999k		0.001k
	1A < FS ≤ 10A	0.000 – 9.999k		0.001k
		10.00 – 99.99k		0.01k
	10A < FS ≤ 100A	0.00 – 99.99k		0.01k
		100.0 – 999.9k		0.1k
	100A < FS ≤ 3000A	0.0 – 999.9k		0.1k
		1.000 – 9.999M		0.001M

FS = full scale clamp ; V_{mis} = voltage reference for power measurement

Energy – Single phase and three phase systems (@ cosφ>0.5, V_{mis}>60V)

Parameter [Wh, VARh, VAh]	FS clamp	Range [Wh, VARh, VAh]	Accuracy	Resolution [Wh, VARh, VAh]
Active Energy Reactive Energy Apparent Energy	FS ≤ 1A	0.0 – 999.9	$\pm (1.0\%rgd + 6dgt)$	0.1
		1.000 – 9.999k		0.001k
	1A < FS ≤ 10A	0.000 – 9.999k		0.001k
		10.00 – 99.99k		0.01k
	10A < FS ≤ 100A	0.00 – 99.99k		0.01k
		100.0 – 999.9k		0.1k
	100A < FS ≤ 3000A	0.0 – 999.9k		0.1k
		1.000 – 9.999M		0.001M

FS = full scale clamp ; V_{mis} = voltage reference for power measurement

Power factor (cosφ)

Range	Resolution	Accuracy
0.20 ÷ 0.50	0.01	1.0
0.50 ÷ 0.80		0.7
0.80 ÷ 1.00		0.6

Flicker Pst1', Pst, PLt

Range	Resolution	Accuracy
0.0 ÷ 10.0	0.1	Compliance to EN50160



5. GENERAL SPECIFICATIONS

DISPLAY:

Features:	graphic TFT with backlight, ¼ VGA (320 x 240)
Touch screen:	present
Colours:	65536
Contrast:	adjustable

POWER SUPPLY:

Internal power supply:	Li-ION, 3.7V rechargeable battery
Battery life:	> 6 hours
External power supplier:	AC/DC adapter
Auto power off:	after 5 minutes without using the instrument (no external power)

MEMORY AND PC INTERFACE

Every parameter could be stored into the memory, the instrument saves the MIN, AVG and MAX value of the parameters each integration period which could be: 1, 2, 5, 10, 30 seconds, 1, 2, 5, 10, 15, 30, 60 minutes

Maximum parameters to be stored:	251
Memory:	> 3 months @ 251 parameters and integration period = 15 min
Internal memory:	15 Mbyte
External memory:	USB pen drive
External memory:	compact flash card
Operative system:	Windows CE
PC communication port:	USB

The instrument could store **SIMULTANEOUSLY** the following parameters:

- voltages, currents, power factors, powers, energies, etc.
- ingoing and outgoing power
- voltage anomalies
- voltage unbalance
- voltage and current harmonics
- flicker
- voltage spikes (PQA824 only)

MECHANICAL FEATURES

Dimensions (L x W x H):	235 x 165 x 75 mm
Weight (batteries included):	1.0 kg
IP degree:	IP40

ENVIRONMENTAL CONDITIONS:

Reference temperature:	23°C ± 5°C
Working temperature:	0°C ÷ 40°C
Working humidity:	<80%RH
Storage temperature (batt. not included):	-10°C ÷ 60°C
Storage humidity:	<80%RH

GENERAL REFERENCE STANDARDS:

Safety:	IEC/EN61010-1
EMC:	IEC/EN61326-1
Insulation:	class 2 (double insulation)
Pollution degree:	2
Overvoltage category:	CAT IV 600V to ground, max 1000V between inputs
Max height of use:	2000m
Power Quality:	EN50160
Quality of electrical power:	IEC/EN61000-4-30 class B
Flicker:	IEC/EN61000-4-15, Ed. 1.0 (2003)
Unbalance:	IEC/EN61000-4-7, EN50160

This instrument complies with the requirements of the European Low Voltage Directives 2014/35/EU (LVD) and EMC 2014/30/EU

This instrument satisfies the requirements of 2011/65/EU (RoHS) directive and 2012/19/EU (WEEE) directive