

SAP5000D

Differential Probe

User Manual

EN01B

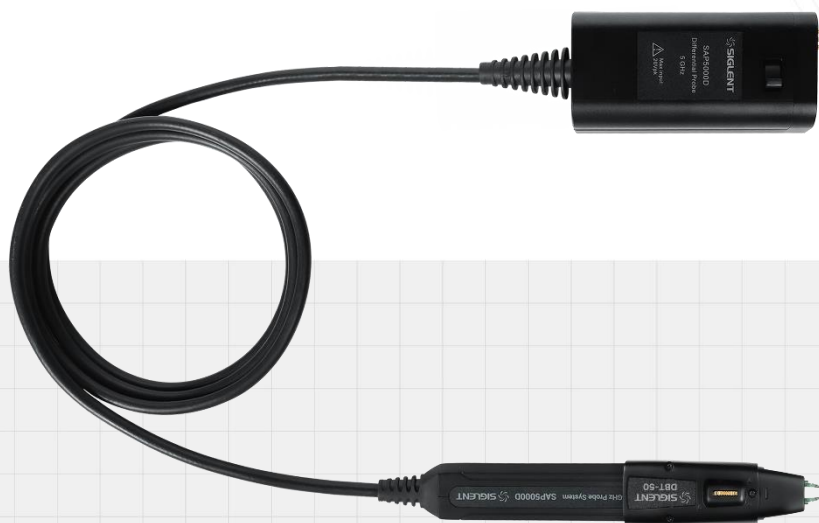

CONTENTS

1	Introduction	2
2	Safety Instructions	3
2.1	Symbols	3
2.2	Operating Environment.....	3
2.3	Calibration.....	4
2.4	Cleaning.....	4
2.5	Abnormalities	4
3	First Steps.....	5
3.1	Delivery Checklist	5
3.2	Functional Check.....	5
3.3	Quality Assurance.....	6
3.4	Maintenance Agreement	6
4	Probe Technical Specifications	7
4.1	Model and Specifications	7
4.2	Accessories	9
4.3	Probe Dimensions	13
5	Probe Operation.....	14
5.1	Connecting the Probe to an Oscilloscope.....	14
5.2	Connecting the Probe to the Test Circuit.....	14
5.3	Probe Head Selection.....	14
5.3.1	DSI-50\SSI-50 Solder-in Heads	15
5.3.2	DRP-45\SRP-45 Socketed Head	17
5.3.3	DBT-50 Adjustable Pin Head.....	18
5.3.4	SMA-50 SMA Head	20
5.4	Soldering-Type Probe Head Usage	22
5.4.1	Soldering Method for Lead Resistance or Silver Wire on the Probe Tip	22
5.4.2	Connecting SAP5000D Probe and Circuit Board with DSI-50 Head.....	25
5.4.3	Removing the DSI-50 Head from the Circuit Board.....	27
5.5	Probe Head Stabilization.....	28

1 Introduction

This user manual contains important safety information related to the SAP5000D Differential Active Probe, as well as a basic tutorial on the probe's operational use.

2 Safety Instructions

This section contains essential information and warnings that must be adhered to while operating the probe under the respective safety conditions. In addition to the safety precautions outlined in this section, you must also follow recognized safety procedures.

1. Connect the probe to the oscilloscope before probing the signal.
2. Intended for indoor use only.
3. Keep the product's surface clean and dry.
4. Do not operate in damp environments.
5. Do not operate in potentially explosive atmospheres.
6. Maintenance procedures should only be performed by qualified technicians.
7. Ensure proper connection of signal wires, keeping the signal ground at the same potential as the ground voltage. Do not connect the ground wire to high voltage sources. During testing, avoid touching exposed contacts and components.
8. If you suspect a product malfunction, refrain from further operation. In the event of suspected damage to the product, seek examination by qualified service personnel.

2.1 Symbols

The following symbol may appear on the product's exterior or within this manual, signifying a need for special attention to safety.

	<p>This symbol is used in areas that require caution. Refer to accompanying information or documents to prevent personal injury or damage to the equipment.</p>
---	---

2.2 Operating Environment

This product is intended for indoor operation only. Before using this product, please ensure that the operating environment remains within the following parameter ranges.

Temperature: 5°C to 40°C.

Humidity: Maximum relative humidity of 80% at 30°C, linearly decreasing to 50% at 40°C.

Altitude: Up to 10,000 feet (3,048 meters).

Note: Consider direct sunlight, electric heaters, and other heat sources when evaluating temperature.

	Warning: Do not operate this product in explosive, dusty, or humid atmospheres.
---	--

	Caution: Do not exceed the specified maximum input voltage. For details, please refer to the technical data.
---	---

2.3 Calibration

The recommended calibration interval is one year and should be performed by personnel with the appropriate qualifications.

2.4 Cleaning

Only use a soft, damp cloth to clean the probe's surface. Do not use chemicals or corrosive substances. Under no circumstances should moisture be allowed to infiltrate the probe. To avoid damaging the probe, disconnect it from the oscilloscope before cleaning.

	The probe case is not sealed and should never be immersed in any fluid.
---	---

2.5 Abnormalities

Use this probe only for the purpose specified by the manufacturer.

The probe may be damaged if it exhibits visible damage or experiences significant transport pressure.

Bending the probe cable may affect the high-frequency performance of the probe.

If you suspect probe damage, disconnect it from the oscilloscope immediately.

To use the probe correctly, carefully read all instructions and labels.

	Warning: Using the probe in a manner not specified by the manufacturer may damage the probe. This probe and related accessories should not be directly connected to the human body or used for patient monitoring.
---	---

3 First Steps

3.1 Delivery Checklist

First, check that all items listed on the packing list have been delivered. If you note any omissions or damage, please contact your nearest SIGLENT customer service center or distributor as soon as possible. If you fail to contact us immediately in case of omission or damage, we will not be responsible for replacement.

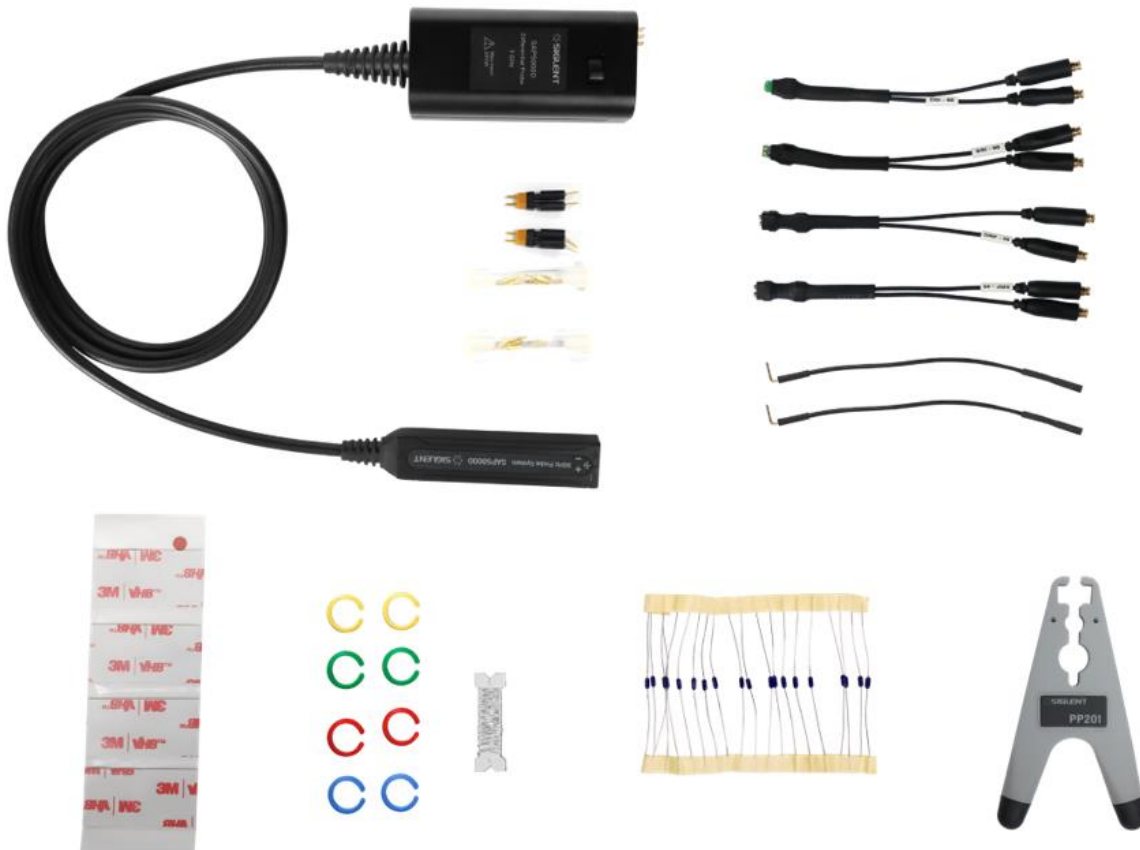

3.2 Functional Check

To perform a function check, you will need an oscilloscope with SAPBus interface support. Follow these steps to check the probe's function:

1. Power on the oscilloscope and allow it to warm up for 20 minutes.
2. Connect the active probe to Channel 1 of the oscilloscope.
3. Open the parameter panel for Channel 1 and inspect the probe information, including the probe model, serial number, bandwidth, impedance, capacitance, and attenuation ratio.
4. Set the vertical scale for Channel 1 to 1 V/div.
5. Set the offset voltage for Channel 1 to 0 V.
6. Measure the average voltage for Channel 1. The reading should be within $\pm (1.5\% * \text{full-scale reading} + 10 \text{ mV})$. If the reading is outside this range, the check does not pass.

- Change the vertical scale for Channel 1 to 500mV/div, 200mV/div, 100mV/div, 50mV/div, 20mV/div, and 10mV/div, respectively. Repeat step 6 for each scale to check the average voltage readings at each scale level.

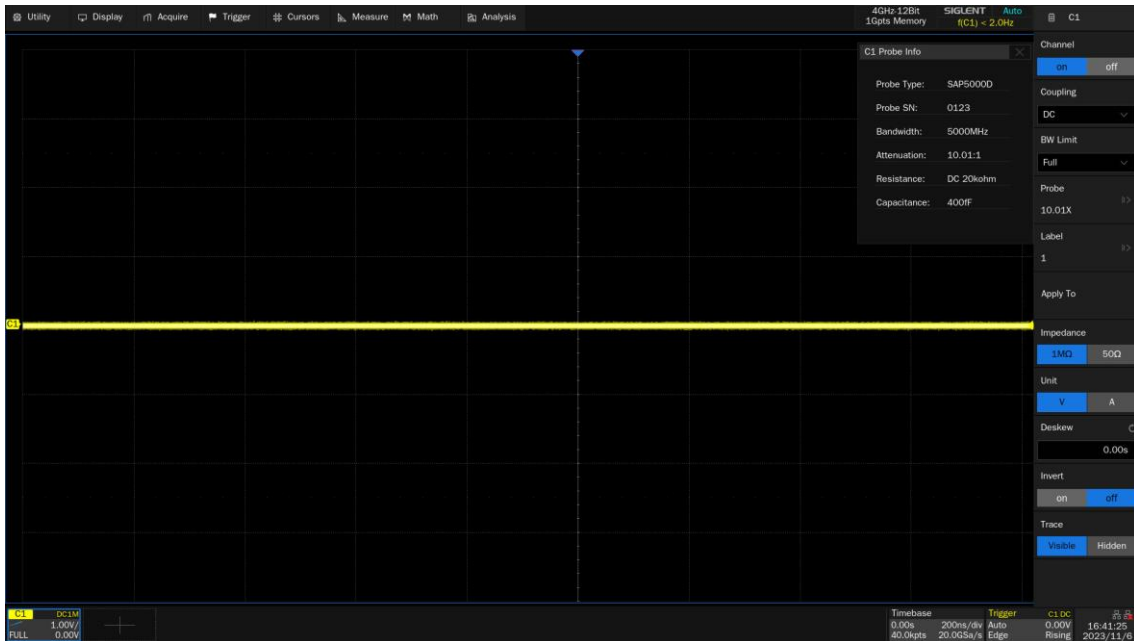

3.3 Quality Assurance

The probe is covered by a 1-year warranty from the date of shipment, provided it is used and operated under normal conditions. SIGLENT can repair or choose to replace any product returned to an authorized service center during the warranty period. We must first examine the product to make sure that the defect is caused by the process or material, not by abuse, negligence, accident, abnormal conditions, or operation.

SIGLENT shall not be responsible for any defect, damage, or failure caused by any of the following:

- Repairs or installation conducted by individuals not authorized by SIGLENT.
- Connection of incompatible devices and improper connections.
- Any damage or failure resulting from the use of products provided by non-SIGLENT suppliers.

3.4 Maintenance Agreement

We offer various services through maintenance agreements. We offer extended warranties, and you can create a maintenance cost budget after the one-year warranty period. We offer installation, training, enhancements, on-site repairs, and other services through dedicated supplementary support agreements. For more information, please contact the SIGLENT customer service center or your national distributor.

4 Probe Technical Specifications

SAP5000D is a high-bandwidth differential active probe known for its features such as high bandwidth, low noise, and high input impedance, making it suitable for measuring high-speed signals. Its high input resistance and low input capacitance characteristics ensure minimal load introduced to the measurement system.

The SAP5000D active probe utilizes the SAPBus interface and is compatible with oscilloscopes that support the SAPBus interface, such as the SDS3000X HD, SDS5000X, SDS6000 Pro, and SDS7000A series oscilloscopes. The SAP series active probes do not require external power sources as the oscilloscope provides power and communication interface to the active probe through the SAPBus interface. When connected to the oscilloscope, the SAP series active probes allow you to read probe information from the oscilloscope's interface.

Here are the performance characteristics:

- Probe Bandwidth: DC to > 5 GHz
- Single-ended input resistance: 10 k Ω
- Differential input resistance: 20 k Ω
- Probe gain: $\div 10$
- Differential input capacitance: 400 fF
- ± 2.5 V input dynamic range
- ± 12 V offset voltage setting range
- SAPBus interface

4.1 Model and Specifications

The specifications of the probe need to meet the following conditions:

1. The probe is within its valid calibration period.
2. The environmental temperature is within $25^{\circ}\text{C} \pm 5^{\circ}\text{C}$.
3. The probe is correctly connected to the oscilloscope.
4. The probe and oscilloscope are in a thermally stable environment, and both the probe and oscilloscope have been preheated for at least 20 minutes.

Probe Model and Specification Parameters:

Parameters	SAP5000D
Bandwidth (Probe only)	> 5 GHz
Bandwidth (with Oscilloscope)	4 GHz (SDS7404A)
Differential input capacitance	400fF
Differential input resistance	20 kΩ
Single-ended input resistance	10 kΩ
Offset range	± 12 V
Attenuation ratio (DC)	÷ 10
Offset accuracy	< 3%
DC gain accuracy	< 3%
Input dynamic range	± 2.5 V
Damage voltage	20 V
Cable length	130 cm

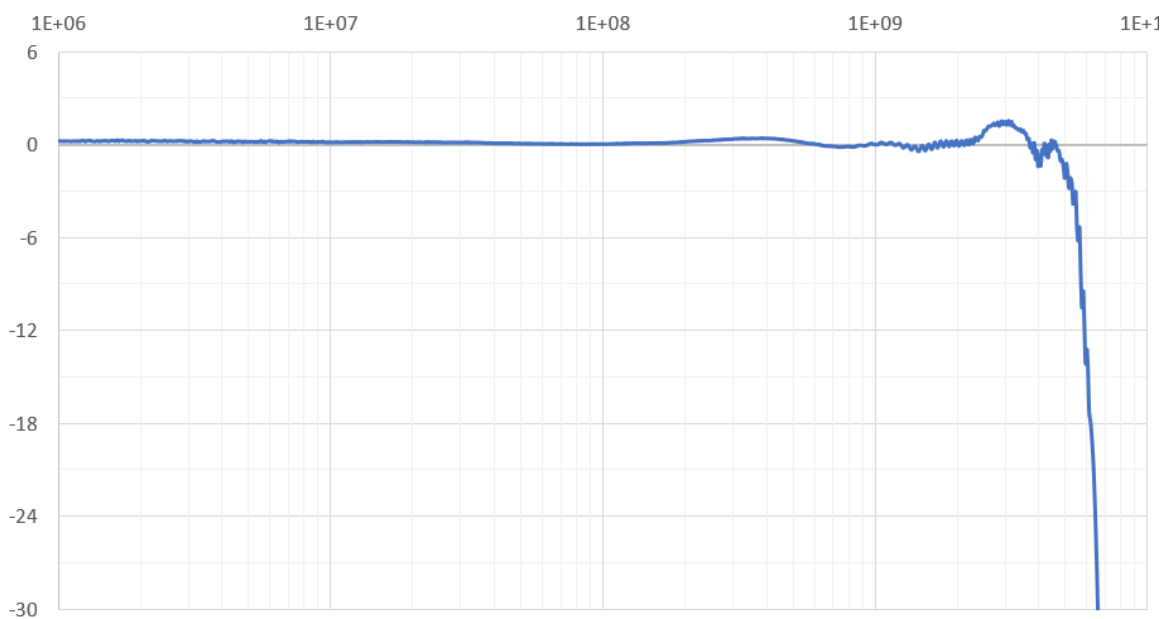

SAP5000D Frequency Response (DSI-50 Soldered 24.9Ω Lead Resistance)

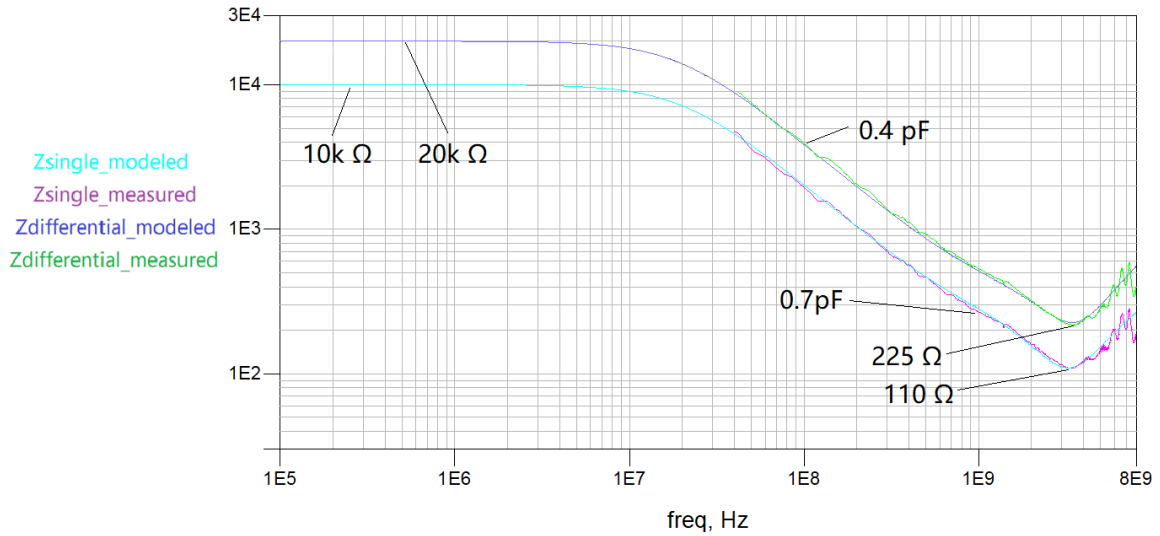

SAP5000D Input Impedance (DSI-50 Soldered 24.9Ω Lead Resistance)

4.2 Accessories

The accessories included with SAP5000D are as follows:

Standard Accessories	Part Number	Quantity	Unit
Solder-in Differential Head DSI-50	1.99.20.10.044	1	pcs
Solder-in Single-ended Head SSI-50	1.99.20.10.043	1	pcs
Socketed Differential Head DRP-45	1.99.20.10.041	1	pcs
Socketed Single-ended Head SRP-45	1.99.20.10.042	1	pcs
10cm Ground Wire	2.52.42.11.018	2	pcs
24.9Ω Lead Resistor	2.45.01.01.305	20	pcs
Silver Wire	2.52.42.11.037	1	Meter
Colored Rings (4 colors)	2.75.23.10.005	2	set
Straight Tip	2.74.70.12.003	5	pcs
Pogo Tip	2.74.70.12.011	5	pcs
Swivel Tip	2.74.70.10.018	2	pcs
Two-legged Positioner PP201	2.78.50.20.027	1	pcs
3M Double-sided Tape	2.78.25.10.047	10	pcs

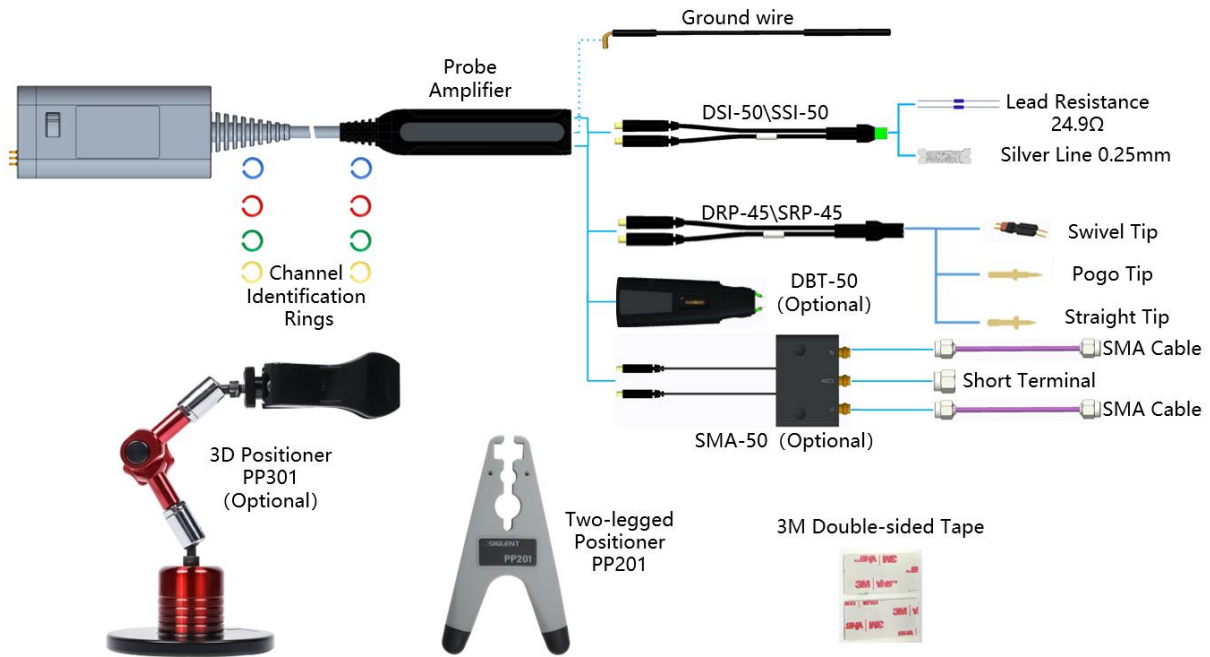

Probe Accessories Illustration

Optional accessories	Part Number	Quantity	Unit
SMA Head SMA-50	0.01.80.10.125	1	pcs
Adjustable Pin Head DBT-50	0.01.80.10.131	1	pcs
3D Positioner PP301	0.01.80.10.136	1	pcs
SAP5-KIT	0.01.80.10.082	1	set
SAP5-DRP45	0.01.80.10.083	1	set
SAP5-SRP45	0.01.80.10.085	1	set
SAP5-DSI50	0.01.80.10.084	1	set
SAP5-SSI50	0.01.80.10.086	1	set



Straight Tip: Universal ejector, small size, with sharp needle, for use with DRP-45\SRP-45.



Pogo Tip: The elastic ejector pin provides more reliable contact during detection and is used with DRP-45\SRP-45.



Swivel Tip: The probe can be rotated to adapt to various test spacings. Used with DRP-45\SRP-45.



Silver Wire: 0.25mm diameter, connects DUT and probe tip

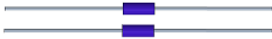

Lead Resistor: 24.9Ω, lead diameter 0.4mm, connecting DUT and probe tip.



Solder-in Head DSI-50\SSI-50: SMP interface, connected to the probe amplifier, the tip can be welded with lead resistor or silver wire.



Socketed Head DRP-45\SRP-45: SMP interface, connected to the probe amplifier. The distance between the two holes is 2.54mm.

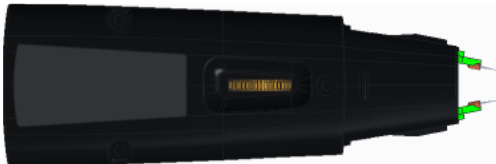

Adjustable Pin Head DBT-50: SMP interface, connected to the probe amplifier. The distance of two pins can be adjusted by the roller.



SMA Head SMA-50: SMP interface, connected to the probe amplifier. The other end is SMA female.



SMA Cable: 6cm long, connects the SMA-50 header and the SMA female connector of the circuit under test.



SMA Short Terminal.



10cm Ground Wire: One end is a pin and the other end is a socket for grounding.



Colored Rings: When multiple probes are used, it is used to distinguish the oscilloscope channels to which the probes are connected.



3M Double-sided Tape: Used to fix solder-in heads.



Two-legged Positioner PP201: Used to fix the probe.



3D Positioner PP301: Used to fix the probe.

- SAP5-KIT:** Accessory kit, for purchasing additional accessories when standard accessories are damaged. Includes 20 lead resistors, 1 10 cm ground wire, 1 meter of silver wire, 2 swivel tips, 5 straight tips, 5 pogo tips, 1 set of color rings, and 10 pieces of 3M double-sided tape.
- SAP5-DRP45:** Accessory kit, for purchasing additional accessories when standard accessories are damaged. Includes 1 socketed head DRP-45, 2 swivel tips, 5 straight tips, 5 pogo tips.
- SAP5-SRP45:** Accessory kit, for purchasing additional accessories when standard accessories are damaged. Includes 1 socketed head SRP-45, 2 swivel tips, 5 straight tips, 5 pogo tips.
- SAP5-DSI50:** Accessory kit, for purchasing additional accessories when standard accessories are damaged. Includes 1 solder-in head DSI-50, 20 lead resistors, 1 meter of silver wire.
- SAP5-SSI50:** Accessory kit, for purchasing additional accessories when standard accessories are damaged. Includes 1 solder-in head SSI-50, 20 lead resistors, 1 meter of silver wire.

4.3 Probe Dimensions

Unit: mm

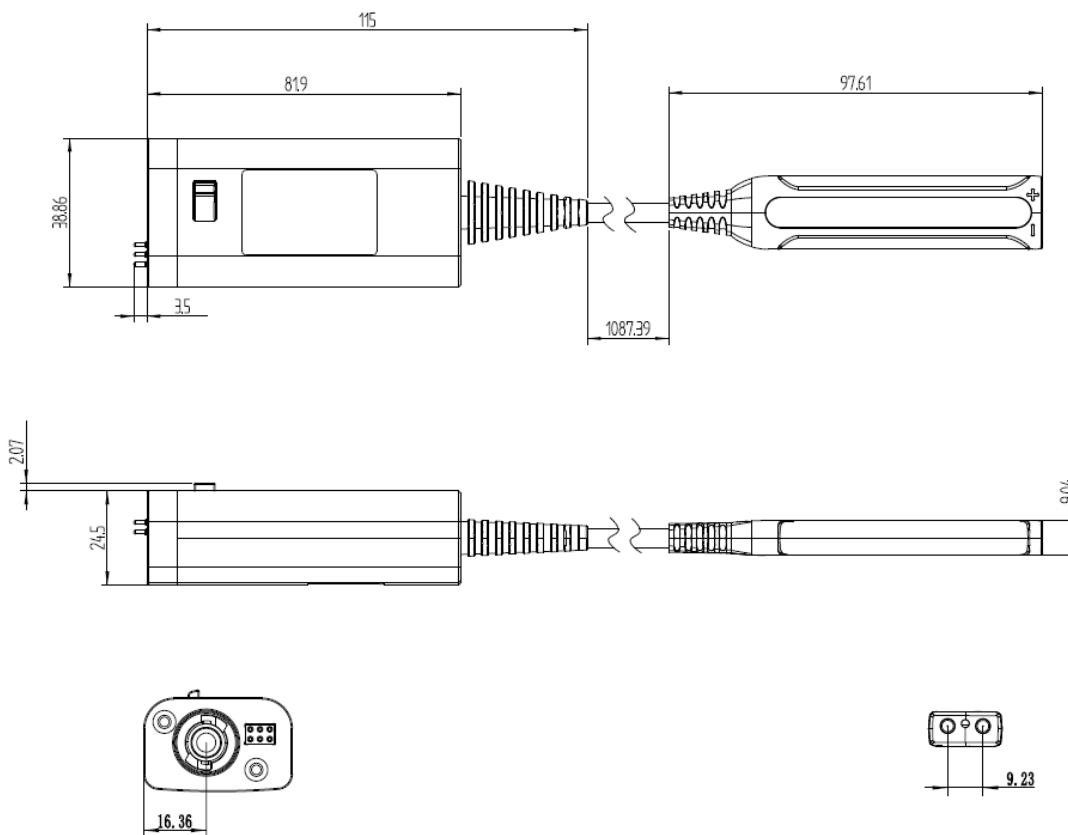

5 Probe Operation

The SAP5000D active probe is a precision test and measurement instrument. Avoid excessive pulling on the cable during use, and when not in use, store the probe in the provided probe pack.



Electrostatic Sensitive: The probe is sensitive to ESD. When using the probe, adhere to ESD protection procedures.

5.1 Connecting the Probe to an Oscilloscope

The SAP5000D is compatible with oscilloscopes that support the SAPBus interface, such as the SDS3000X HD, SDS5000X, SDS6000 Pro, and SDS7000A series oscilloscopes.

When the probe is connected to the oscilloscope, the oscilloscope can automatically identify the probe model and adjust display scales and measurements accordingly. Basic information about the probe, such as the model and serial number, can be viewed on the oscilloscope's user interface. After connecting the probe, the maximum vertical scale on the oscilloscope is 1V/div, and the DC offset can be set in the range of ± 12 V.

5.2 Connecting the Probe to the Test Circuit

The internal amplifier of the probe has a limited linear operating range. To ensure that the input linearity error is less than 1%, the amplitude of the input signal needs to be limited to ± 2.5 V. The probe features a DC offset adjustment function, which allows you to offset the DC component in the test signal for optimal probe performance. The DC offset adjustment range is ± 12 V.

When using the probe to test signals, it's essential to minimize parasitic capacitance or inductance introduced in the test setup to ensure probe performance. Parasitic inductance or capacitance can lead to ringing during fast edge testing or slow down the rise time of fast edges.

To reduce the test loop, keep the soldered leads as short as possible and minimize the ground path's length. Otherwise, the test loop may couple with electromagnetic fields in the environment, resulting in increased noise picked up by the probe.

Probes are sensitive to ESD. Follow ESD protection procedures when using the probe to prevent damaging the probe.

5.3 Probe Head Selection

Different probe heads are suitable for different usage scenarios, and users can choose as needed.

5.3.1 DSI-50\SSI-50 Solder-in Heads

The DSI-50 probe head can measure differential signals with full bandwidth and low input capacitance. The SSI-50 probe head can measure single-ended signals. These tips of heads can be soldered to the DUT, freeing up hands and providing a reliable connection. We provide leads with a minimum diameter of 0.25 mm, allowing signal acquisition at very small and narrow measurement points.

When using silver wire welding, the high-frequency gain will be too large. If you want to get a lower gain in the high-frequency band, you need to change the damping resistor on the head PCB to 24.9Ω. The default resistance is 0 Ω.



Head Models	Bandwidth (GHz)	Input Capacitance (fF)	Purpose
DSI-50	5	400	Measure Differential Signals
SSI-50	5	800	Measure Single-Ended Signals

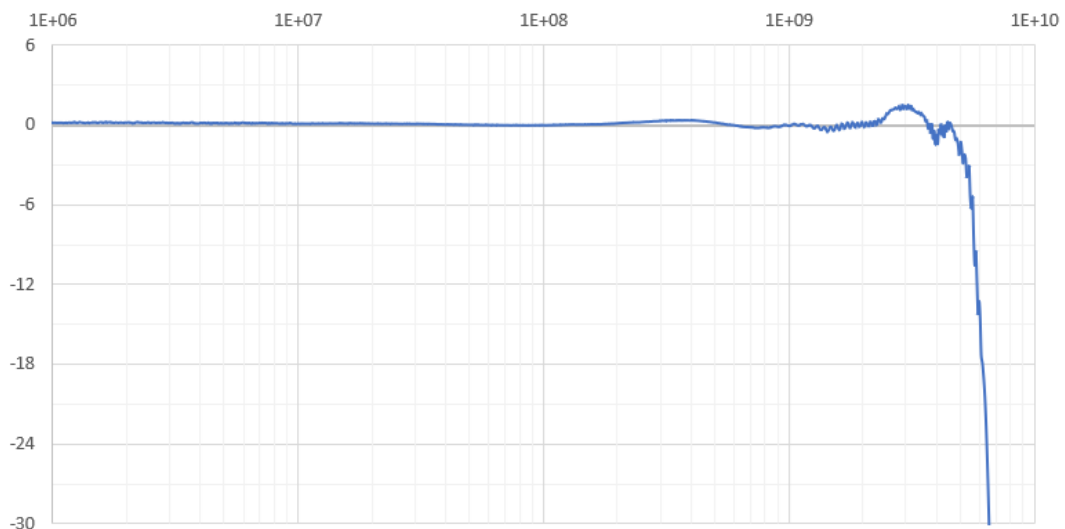
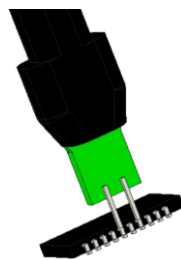

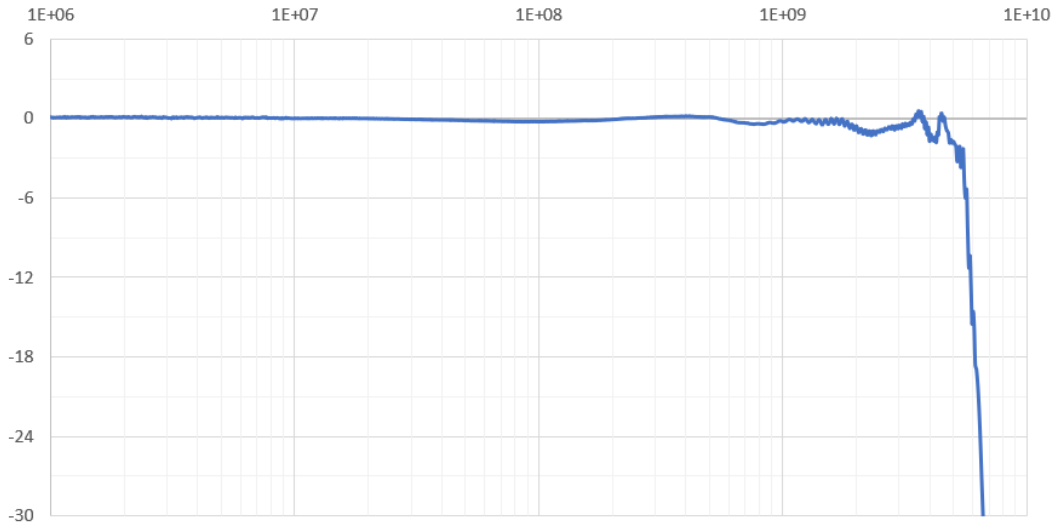

DSI-50 frequency response curve (welding 24.9R resistor)





SSI-50 frequency response curve (welding 24.9R resistor)

	<p>If you need to replace the lead resistance or silver wire on the probe tip, please refer to "Section 5.4.1 Soldering Method for Lead Resistance or Silver Wire on the Probe Tip."</p>
--	--

	<p>Avoid applying too much solder to the lead resistance body, as it may cause damage to the resistance.</p>
---	--

	<p>When soldering leads onto the DUT, use a sufficient amount of flux. Reliable soldering can be achieved with a moderate amount of solder after using flux.</p>
---	--

	<p>Use a fixed stand or tape to secure the probe and DUT, reducing the stress on the soldering points.</p>
---	--

	<p>When using the SSI-50 to measure single-ended signals, the input terminal corresponding to the white model label is the negative terminal.</p>
---	---

5.3.2 DRP-45\SRP-45 Socketed Head

The straight plug is suitable for connecting with 2.54 mm pitch pin headers, and is used for USB testing, Ethernet testing, etc. These probe heads is plug-and-play, and the standard probe can also be used for point testing, greatly improving test efficiency.



Head Models	Bandwidth (GHz)	Input Capacitance (fF)	Purpose
DRP-45	4.5	800	Measure Differential Signals
SRP-45	4.5	1300	Measure Single-Ended Signals

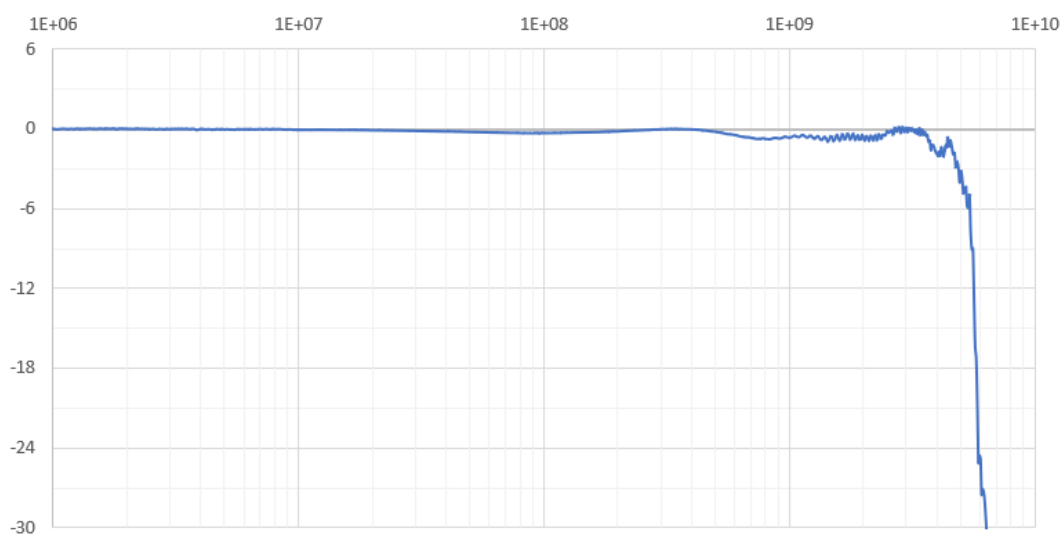

DRP-45 frequency response curve

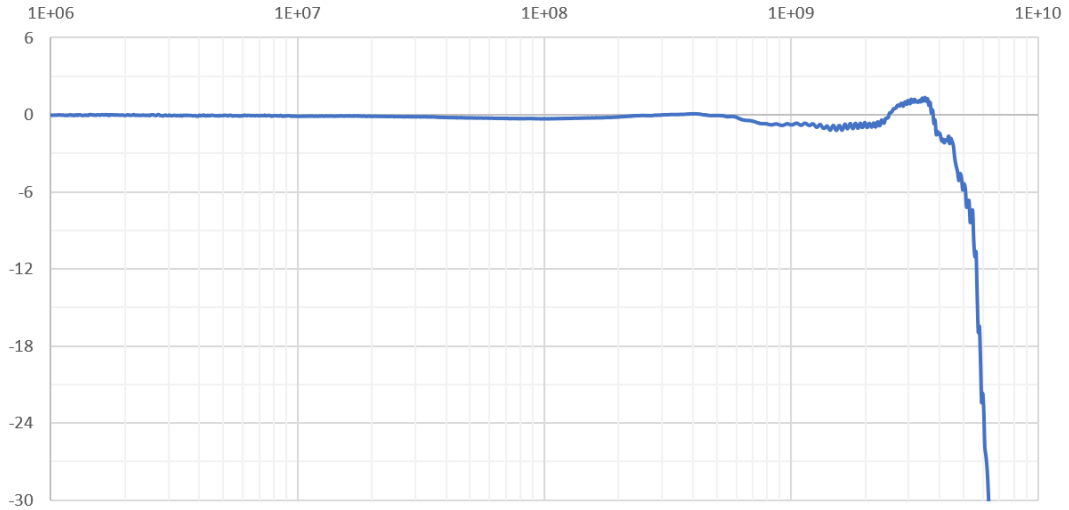

SRP-45 frequency response curve

5.3.3 DBT-50 Adjustable Pin Head

The spacing between the input terminals of the DBT-50 adjustable pin head can be adjusted by scroll wheel, which can quickly measure differential signals with different spacings.



Head Models	Bandwidth (GHz)	Input Capacitance (fF)	Purpose
DBT-50	5	400	Measure Differential Signals, pin spacing is adjustable

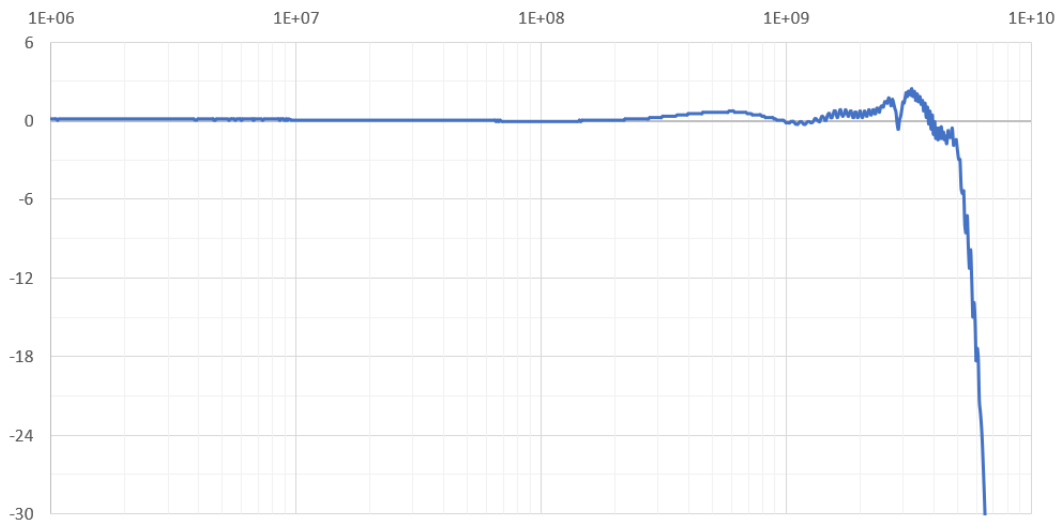

DBT-50 frequency response curve (with tungsten steel pin)



Please connect DBT-50 and probe amplifier as shown above, pay attention to the screws and grounding marks in red circles. After installation, it will look like the following picture.

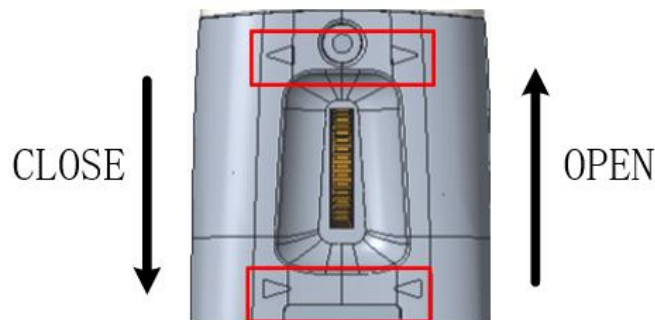

The input end spacing of DBT-50 can be adjusted by rotating the scroll wheel, in the direction of the triangle in the figure above. When rotating downward, the pin spacing becomes smaller, and when rotating upward, the probe spacing becomes larger.



DBT-50 is an optional accessory. The package also includes 4 tungsten steel pins, 10 elastic pins, and plastic tweezers. Users can use plastic tweezers to replace the pin.

5.3.4 SMA-50 SMA Head

The SMA-50 SMA head can be connected to the circuit under test with an SMA interface. The connection method is stable and reliable.

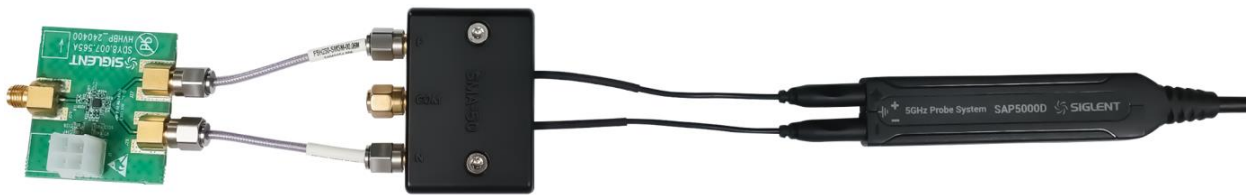

Head Models	Bandwidth (GHz)	Differential Input Resistance (Ω)	Purpose
SMA-50	5	100	Measuring Differential Circuits with SMA Interfaces

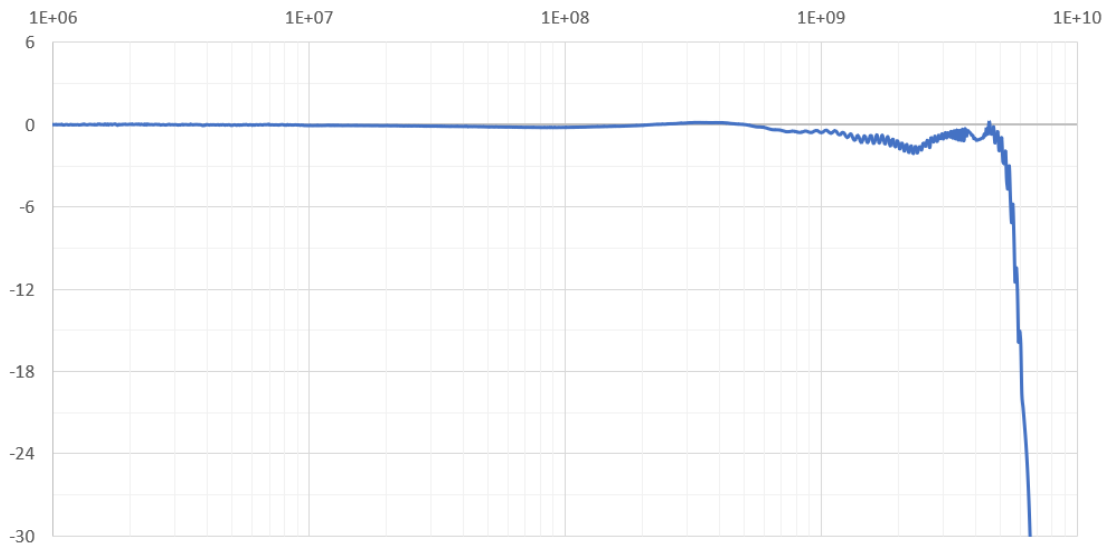

SMA-50 frequency response curve

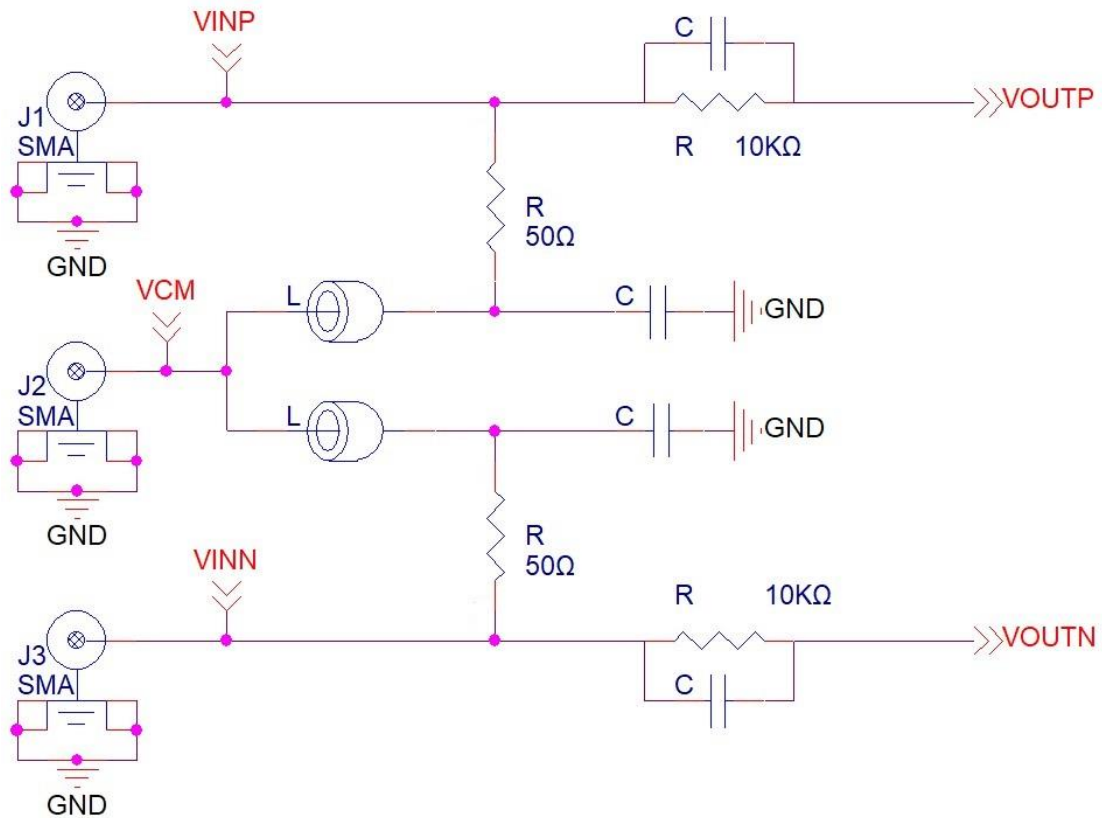

SMA-50 internal schematic diagram

The VCM port is a common mode signal input and output port. When J2 uses a short-circuit cap, the VCM signal is grounded. J2 can also be used as a common mode voltage measurement port. When using SMA to measure single-ended signals, because there is already a 50Ω termination inside, the other input terminal can be left floating.

5.4 Soldering-Type Probe Head Usage

Before using a soldering-type probe head, please carefully read the following usage instructions to avoid damaging the probe and the circuit board under test.

5.4.1 Soldering Method for Lead Resistance or Silver Wire on the Probe Tip

If you need to replace the lead resistance or silver wire due to damage, follow these steps for replacement.

Soldering Preparation

Materials or Tools:
Vise or equivalent fixture for securing the tip.
Adjustable-temperature fine-tip soldering iron.
Solder wire.
Fine stainless steel tweezers.
Flux.
Caliper.
Wire cutters.

Soldering Steps

1. Use a vise or fixture to secure the tip for soldering. If the fixture has sharp edges, wrap it with tape to protect the head.

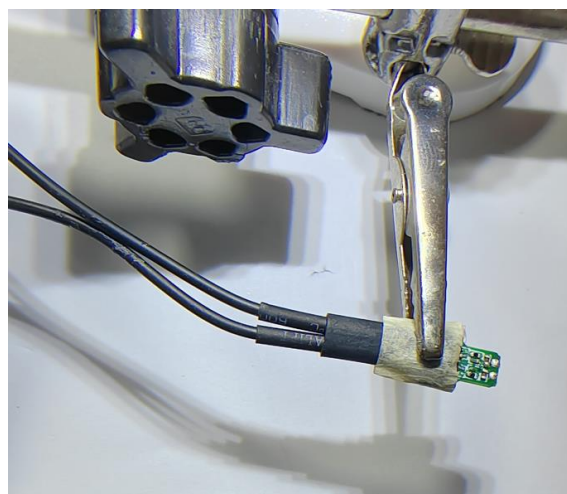

- If you need to remove the existing or damaged leads, grip the leads with tweezers and gently pull them upward. Ensure the soldering iron contacts the solder point for a sufficient amount of time to detach the leads from the tip.

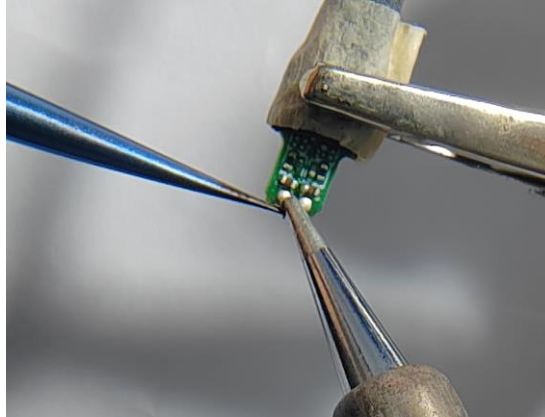

	<p>To avoid overheating and damaging the circuit board, do not allow the soldering iron to contact the solder point for longer than necessary. The solder joints are very small and have low thermal mass, so they will melt quickly.</p>
--	---

- Fill the mounting hole with solder, preparing it for the new leads.
- To reduce the soldering temperature, it is recommended to apply flux to the soldering area.
- Prepare the lead resistance for connection to the head's PCB. Trim the lead resistance leads as shown in the diagram. The wires soldered to the head's PCB should have a 90° bend, with a bend length of about 1mm, to enter the through-hole in the probe tip's PCB. The processed lead resistance should look as shown in the diagram.
- Alternatively, prepare the silver wire and trim it to the state shown in the diagram.

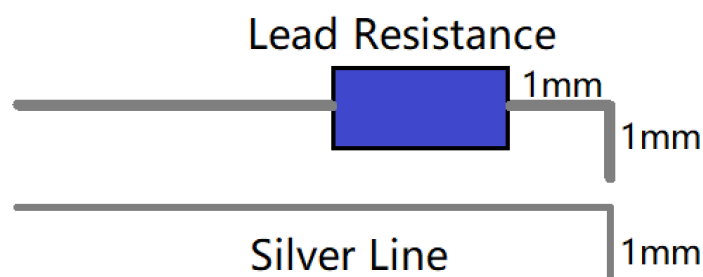

7. Hold the lead of the lead resistance or silver wire with tweezers in one hand, and in the other hand, hold the soldering iron to place the end of the lead resistance or silver wire (the 90° bend) over the filled solder hole. Touch the soldering iron to the side of the hole. As the solder in the hole melts, the lead of the lead resistance or silver wire will drop into the hole. Once the lead drops into the hole, immediately remove the soldering iron.

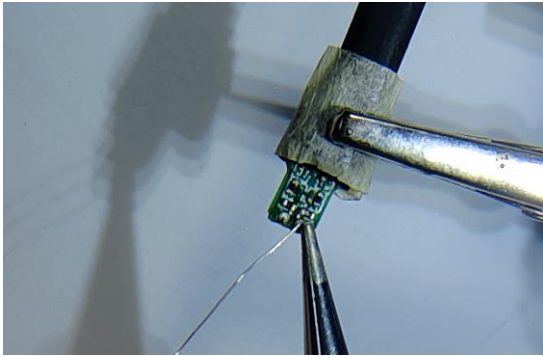

Silver Wire Soldering

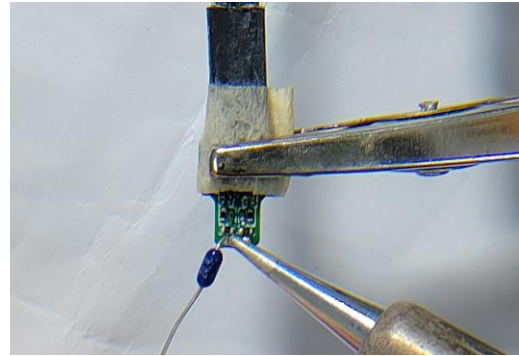

Lead Resistance Soldering

8. After soldering, use wire cutters to trim the lead to a length that is just right to solder to the test point on the circuit board under test. The shorter the lead, the better. For silver wire, a length shorter than 3mm is recommended, and for lead resistance leads, a length shorter than 2mm is suggested.

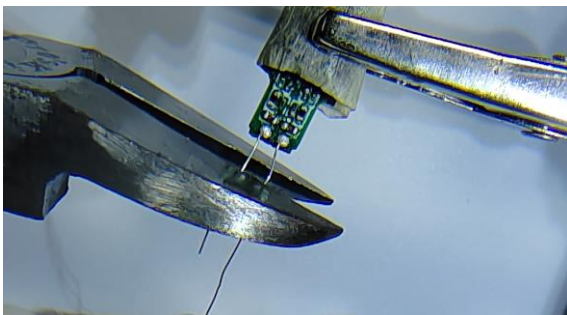

Silver Wire Cutting

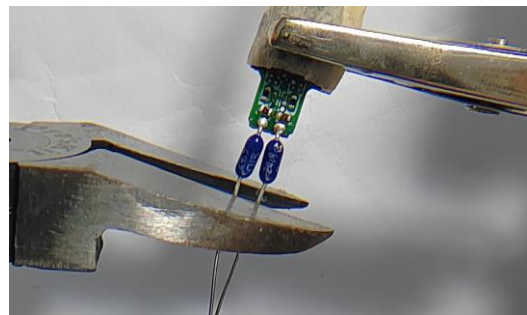

Lead Resistance Cutting

5.4.2 Connecting SAP5000D Probe and Circuit Board with DSI-50 Head

1. Solder the lead resistance or silver wire onto the DSI-50 head as per the soldering method in Section 5.4.1. Apply solder at the location marked in red.

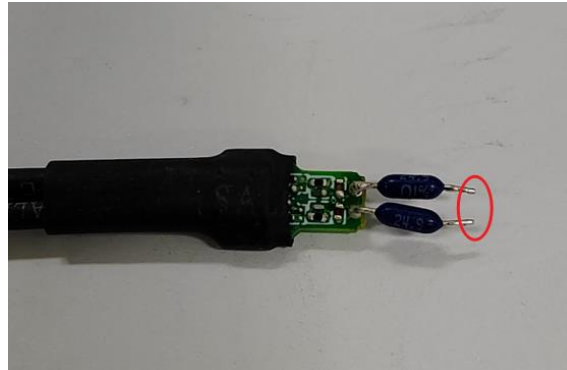

2. Apply flux to the test points on the circuit board, then add solder. If the test points are through-holes, it is recommended to use low-temperature solder.

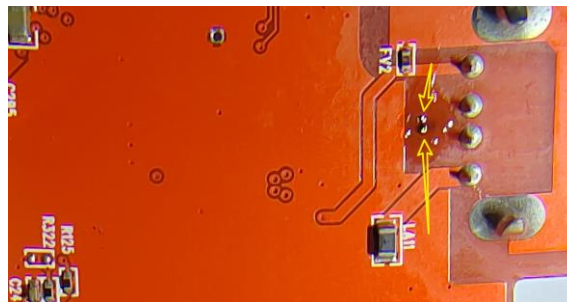

3. Choose the method to secure the probe head.

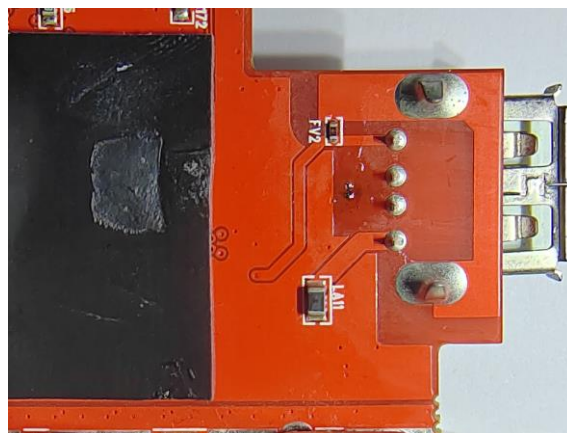

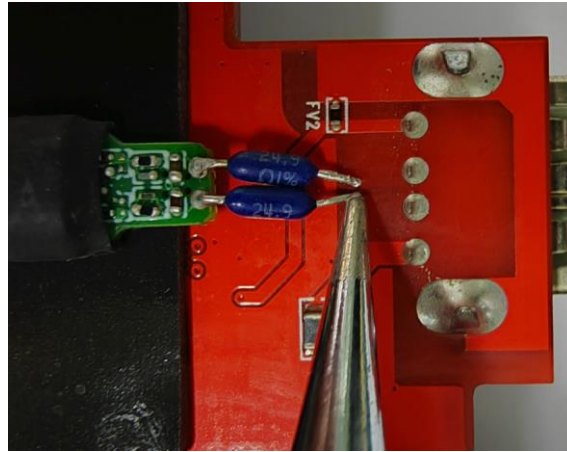

4. Solder the tip of the head to the test points on the circuit board.

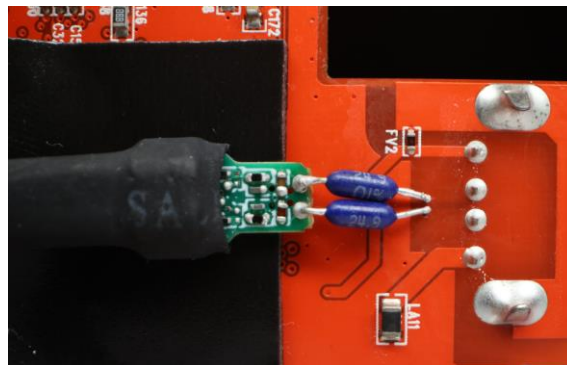

- Clean the flux on the solder joints with board cleaner.



	<p>To avoid overheating and damaging the circuit board, use the lowest possible temperature for the soldering iron, and do not allow the soldering iron to contact the solder points for longer than necessary.</p>
---	---

	<p>The PCB on the probe tip cannot directly touch the circuit board under test, as it will result in inaccurate measurements.</p>
---	---

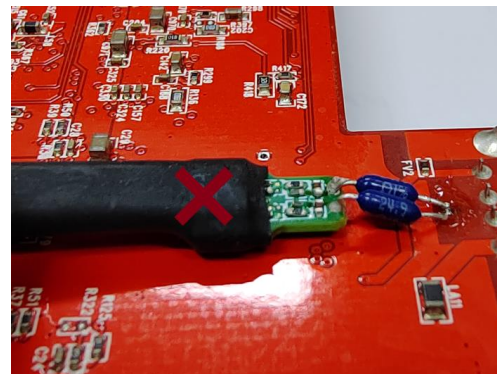
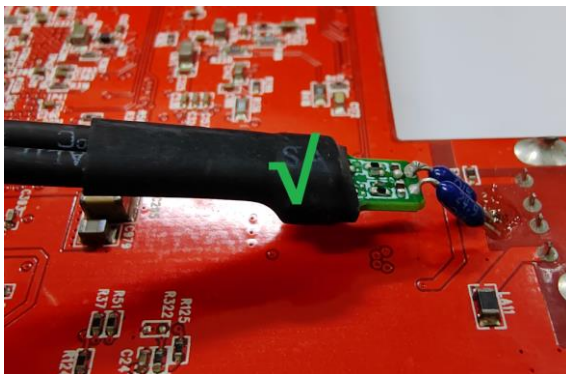

5.4.3 Removing the DSI-50 Head from the Circuit Board

1. First, remove the solder joints.

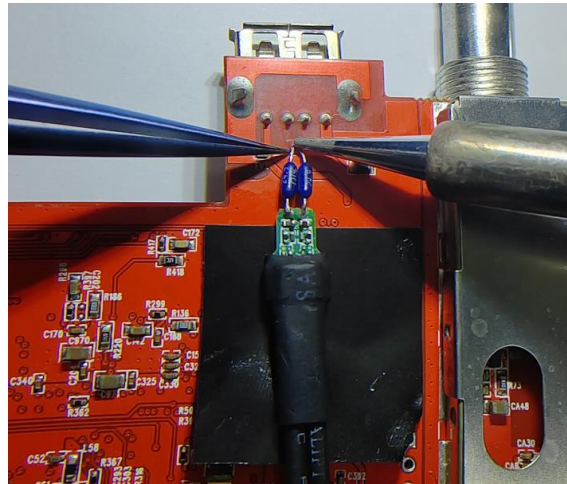

2. Then, carefully remove the probe head.



It's essential to remove the solder joints before unfastening the head to avoid damaging the probe head or the circuit board under test.

5.5 Probe Head Stabilization

During the use of the probe, securely fixing the probe head will extend its lifespan and prevent damage to the test points due to stress. You can use 3M double-sided tape or adhesive tape to secure the probe head.

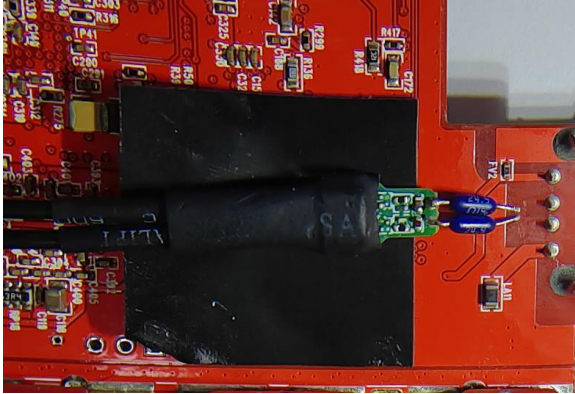

	<p>When using double-sided tape or adhesive tape to fix the probe head, it may inevitably leave marks on the circuit board.</p>
--	---

Use the probe positioner to fix the browser probe, freeing the user's hands.

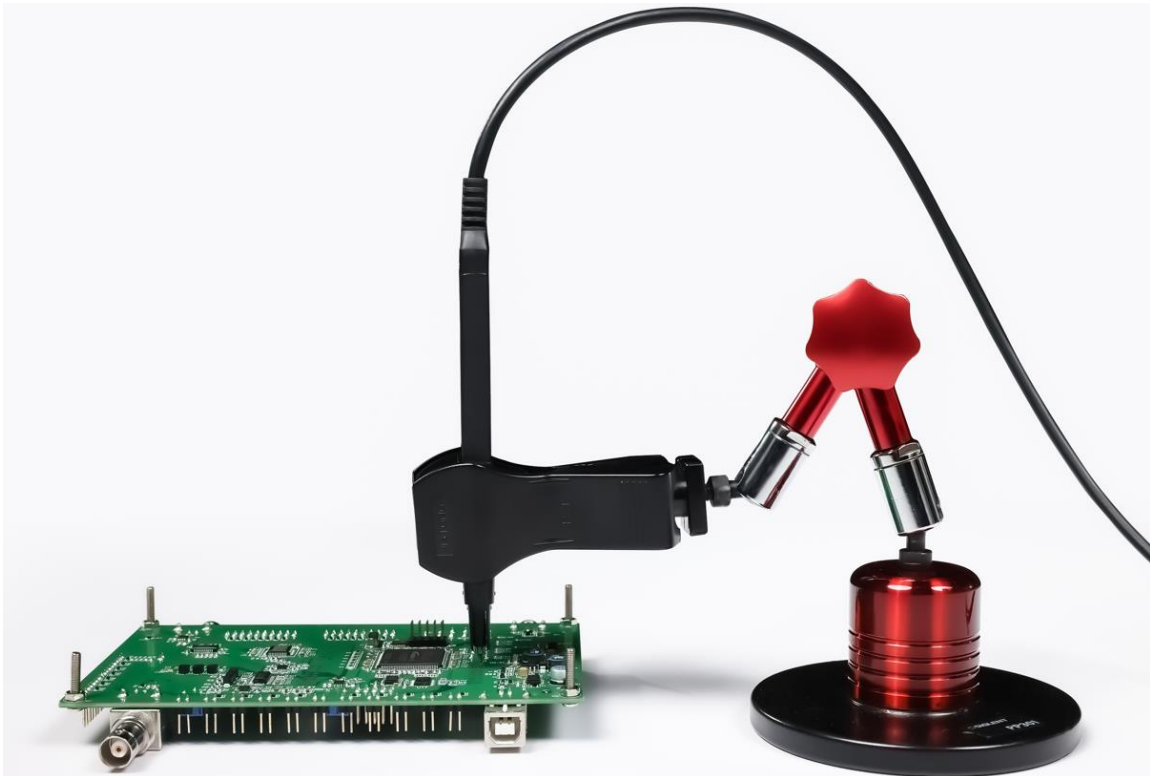

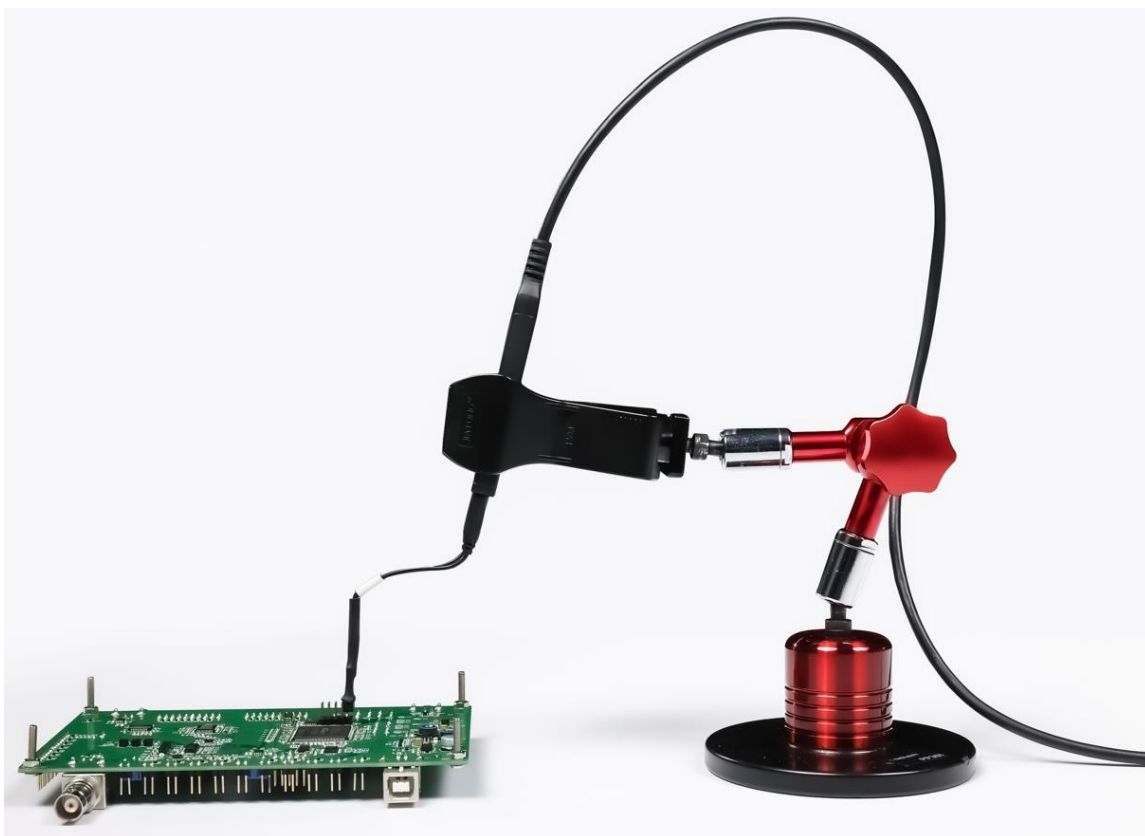
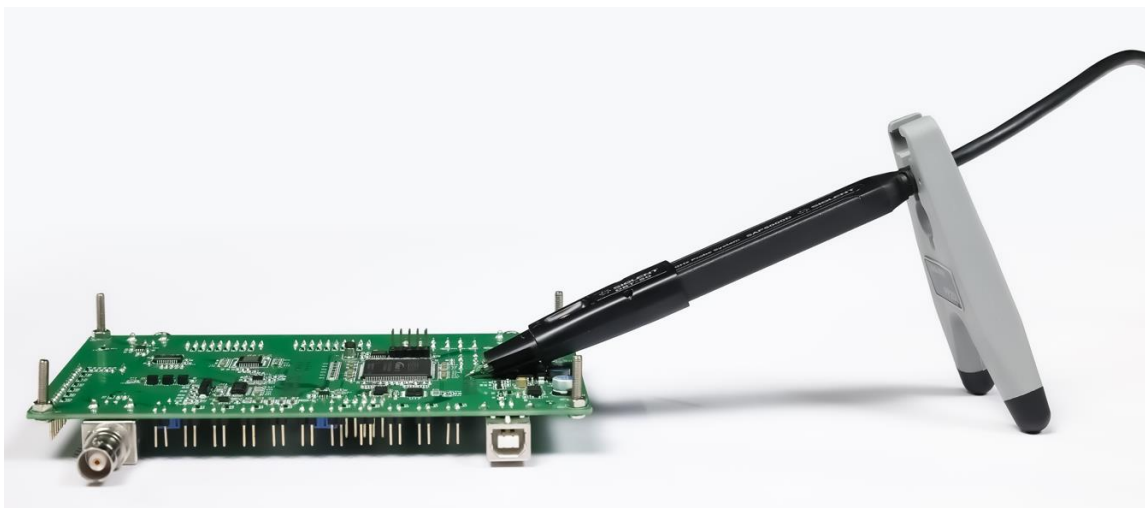



About SIGLENT

SIGLENT is an international high-tech company, concentrating on R&D, sales, production and services of electronic test & measurement instruments.

SIGLENT first began developing digital oscilloscopes independently in 2002. After more than a decade of continuous development, SIGLENT has extended its product line to include digital oscilloscopes, isolated handheld oscilloscopes, function/arbitrary waveform generators, RF/MW signal generators, spectrum analyzers, vector network analyzers, digital multimeters, DC power supplies, electronic loads and other general purpose test instrumentation. Since its first oscilloscope was launched in 2005, SIGLENT has become the fastest growing manufacturer of digital oscilloscopes. We firmly believe that today SIGLENT is the best value in electronic test & measurement.

Headquarters:

SIGLENT Technologies Co., Ltd
Add: Bldg No.4 & No.5, Antongda Industrial
Zone, 3rd Liuxian Road, Bao'an District,
Shenzhen, 518101, China
Tel: + 86 755 3688 7876
Fax: + 86 755 3359 1582
Email: sales@siglent.com
Website: int.siglent.com

North America:

SIGLENT Technologies America, Inc
6557 Cochran Rd Solon, Ohio 44139
Tel: 440-398-5800
Toll Free: 877-515-5551
Fax: 440-399-1211
Email: info@siglentna.com
Website: www.siglentna.com

Europe:

SIGLENT Technologies Germany GmbH
Add: Staetzlinger Str. 70
86165 Augsburg, Germany
Tel: +49(0)-821-666 0 111 0
Fax: +49(0)-821-666 0 111 22
Email: info-eu@siglent.com
Website: www.siglenteu.com

Follow us on
Facebook: SiglentTech



2 7 7 4 0 1 0 6 3 6